

Guideline for Rescue Forces

Vehicles with Alternative Drives

e-tron

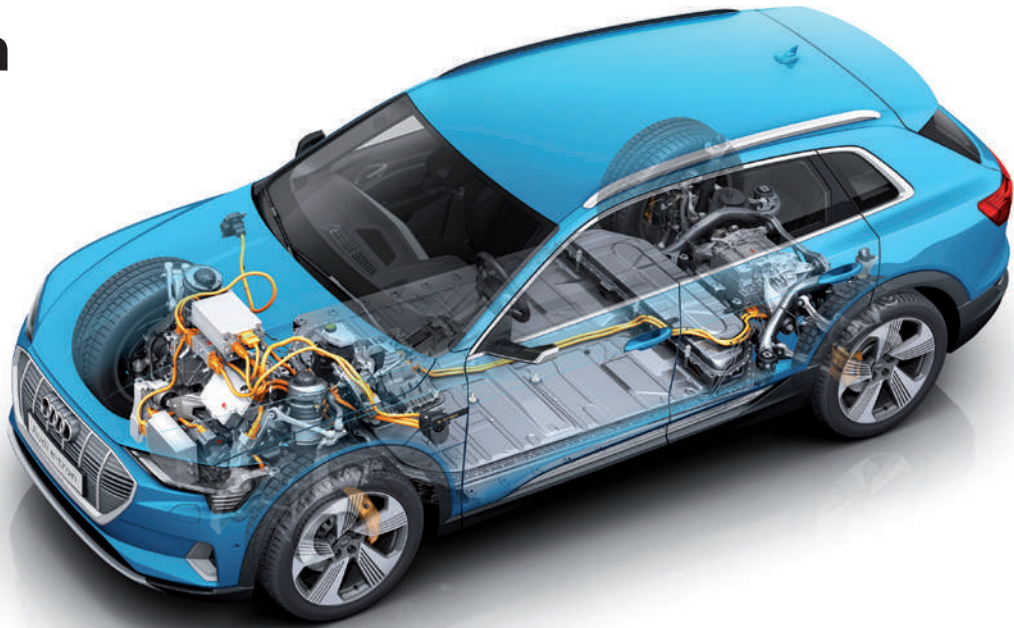

g-tron

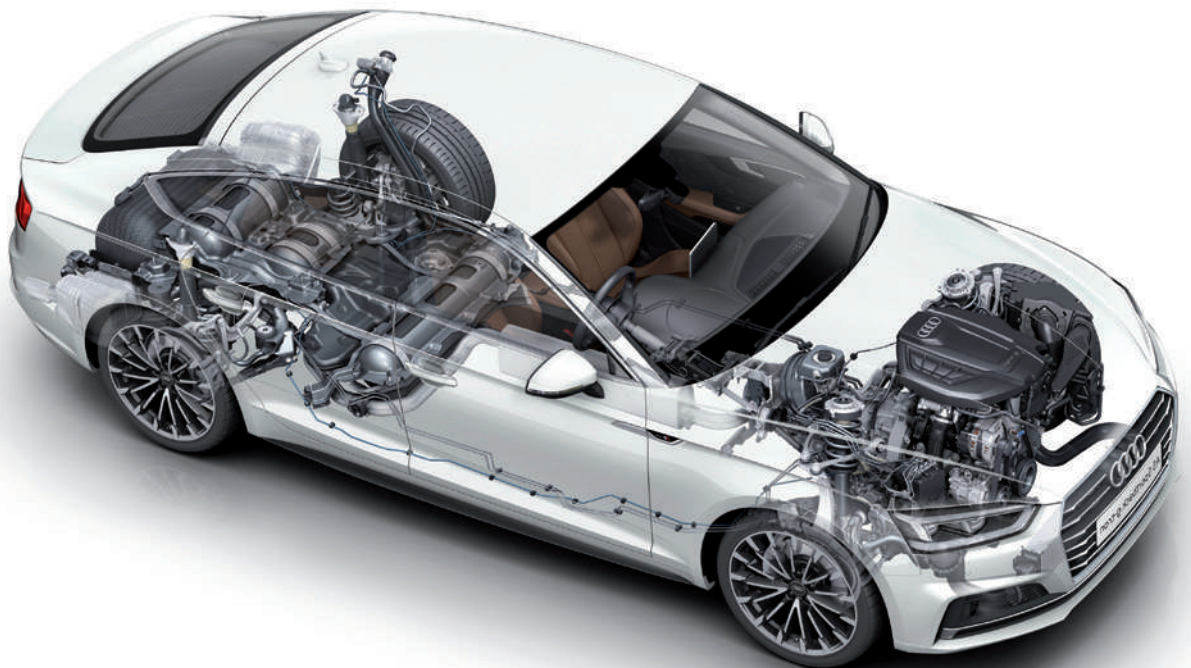

Legal information

This guideline has been prepared exclusively for rescue services which have received special training in the field of the technical assistance after traffic accidents and thus in the area of the activities described in this guide.

The specifications and the special equipment of Audi vehicles as well as the vehicles offered by AUDI AG are continuously subject to possible change.

For this, Audi expressly reserves adaptations and amendments of this document at any time.

Please observe: The information included in this guide is neither intended for final customers nor for workshops or dealers. Final customers can take detailed information about the functions of their vehicle as well as important safety notes about vehicle and passenger safety from the on-board documentation of their respective vehicles. Workshops and dealers receive repair information from the sources known to them.

Copyright

This document is subject to the copyright of AUDI AG, Ingolstadt.

Any duplication, distribution, storage, conveyance, transmission, reproduction or transfer of the content is expressly forbidden without the written permission of AUDI AG.

Table of Contents

Alternative Drives

Foreword	5
----------	---

Hybrid and Electric Drive

Classification of electric drive variants at Audi	7
Vehicle identification – hybrid and electric vehicles (MHEV/HEV/PHEV/BEV)	8
Technical fundamentals	10
High-voltage technology	14
High-voltage battery	15
High-voltage cables and connectors	18
High-voltage components	19
High-voltage safety concept	24
Warning labels	26
Notes for the rescue work	28
Vehicle fire	40
Salvage from water	40
General Safety Information about Lithium-Ion Batteries	41

Natural gas drive (g-tron)

Vehicle identification – Natural gas vehicles	44
Technical fundamentals	45
Safety installations	49
Notes for the rescue work	52
Vehicle fire	54

Alternative Drives

Foreword

Rescue services study alternative drives on a world-wide scale, due to the availability of different drive concepts and the increasing number of vehicle with alternative drives. This applies to the general processes and procedures of rescue activities after traffic accidents, but also to the knowledge about the drive concepts themselves.

In the different countries of the world, the processes and procedures are normally regulated by service regulations or guidelines set up by legislation or by the rescue organizations themselves. If any notes on procedures are given in the present rescue guide, these must be exclusively understood as suggestions.

The main objective of the rescue guideline is to familiarize rescue services with the drive concepts. Apart from the general presentation of the technology, the main focus is on the identification and safety concepts of the different technologies.

Hybrid and Electric Drive

e-tron

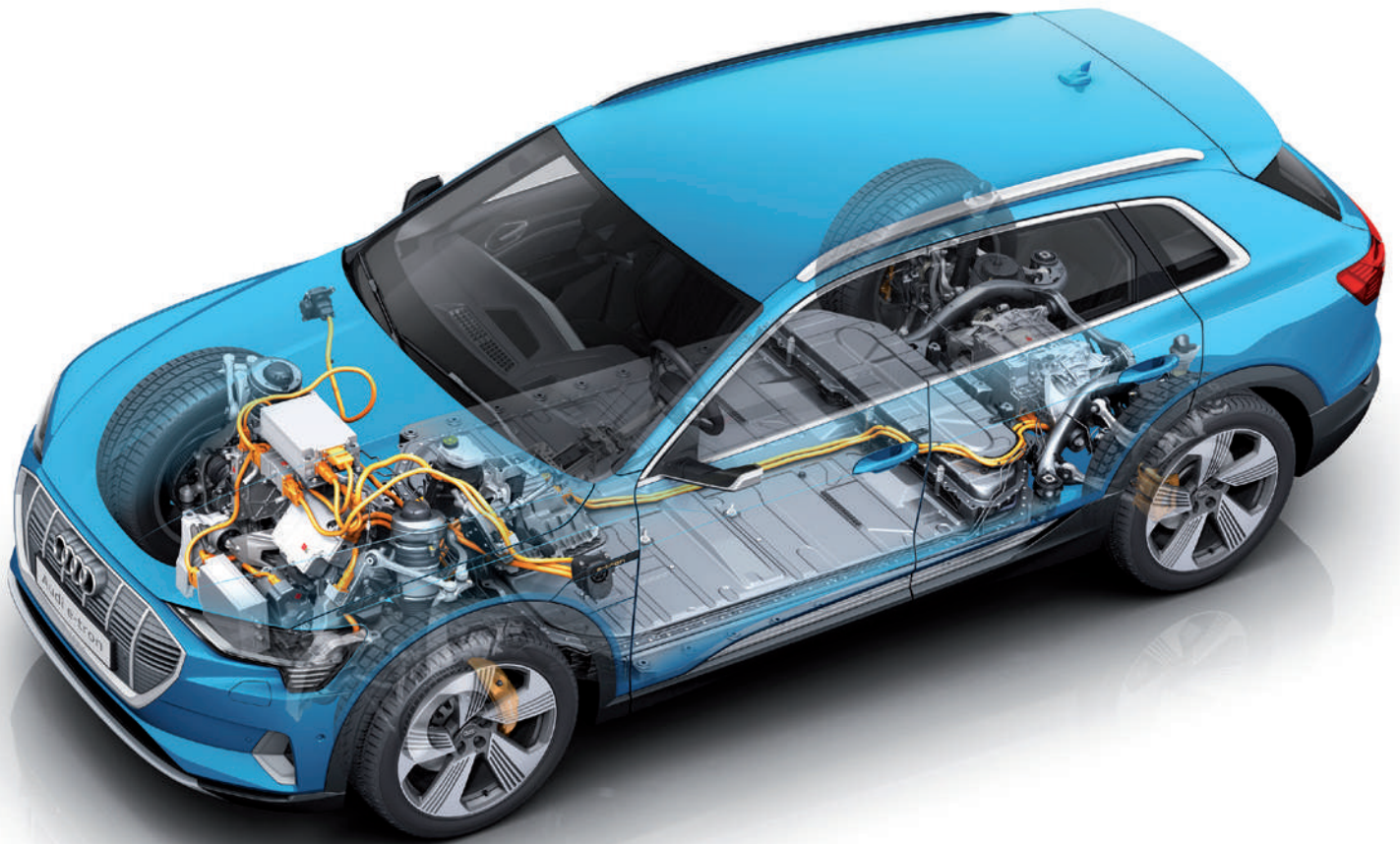









Classification of electric drive variants at Audi

There are different concepts for mild hybrid, hybrid, and electric vehicles. They differ with respect to the primary source of energy, the voltage, the type of traction motor, and the electric driving range.

A differentiation is made between:



- ▶ Mild-Hybrid Electric Vehicle (MHEV)
- ▶ Full-Hybrid Electric Vehicle (HEV)
- ▶ Plug-In-Hybrid Electric Vehicle (PHEV)
- ▶ Battery Electric Vehicle (BEV)

The table shows the different electrification concepts.

	Mild-Hybrid	Full-Hybrid	Plug-In-Hybrid	Battery Electric Vehicle
Voltage	12 – 48 V	200 – 300 V	300 – 450 V	300 – 900 V
Electric motor	10 – 15 kW	20 – 50 kW	60 – 120 kW	> 150 kW
Electric driving range		approx. 3 km	approx. 50 km	> 200 km
Source of energy	 	 	  	 
Examples	Q5 A6 Q8 A7 A4 A8 A5	Q5 hybrid A6 hybrid A8 hybrid	A3 e-tron Q7 e-tron Q5 TFSIe A6 TFSIe A7 TFSIe A8 TFSIe	e-tron e-tron sportback e-tron GT

r002_006

Legend for energy sources

Symbol	Designation
	Traditional fuels e. g. petrol and diesel
	Battery operation
	Battery operation with charging possibility via socket

Vehicle identification – hybrid and electric vehicles (MHEV/HEV/PHEV/BEV)

Vehicles with alternative drive concepts can be identified according to different distinguishing characteristics. Having this knowledge, rescue services can adapt their activities to the corresponding technology of the vehicles involved in an accident.

Distinguishing characteristics – hybrid and electric vehicles (examples)

Logo types on the car body exterior

For Audi, high-voltage vehicles (full, plug-in hybrid and pure electric vehicles) can be identified by the lettering “hybrid”, “e-tron”, or by the letter “e” in the technology lettering. An additional feature for battery electric vehicles (BEV) is that there is no exhaust pipe.



The logo types are different between the models, and some can optionally be deselected during vehicle configuration. It is also possible that the vehicle owners remove them.

There are no external differences between mild hybrid vehicles (MHEVs) and conventional Audi vehicles.



Lettering on the cover of the charging socket
(right side shown in the example)

r003_112



r001_085



Technology lettering on the tailgate
(or fender)

r001_101



r003_115

Interior lettering



r001_040

Audi virtual cockpit with e-tron lettering and power meter (left display)

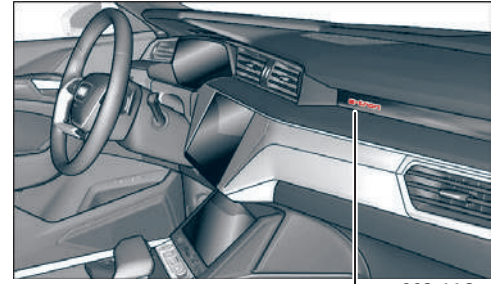

r003_116

Lettering on the control panel



r001_086

Lettering on the door sill strips

Lettering on the design cover in the engine compartment and orange coloured high-voltage cable



r003_120

Lettering on the design cover in the engine compartment

Charging socket



Not every hybrid vehicle variant is equipped with a charging socket. Charging sockets may be located on the front of the vehicle, on the front left or right fender or on the rear side of the vehicle.

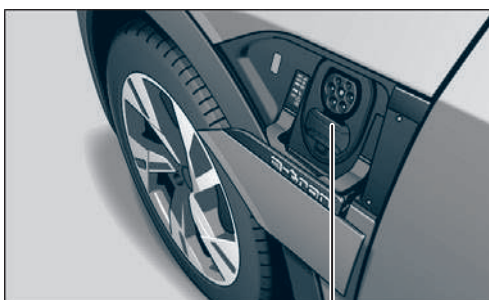

r003_122

Lateral charging socket

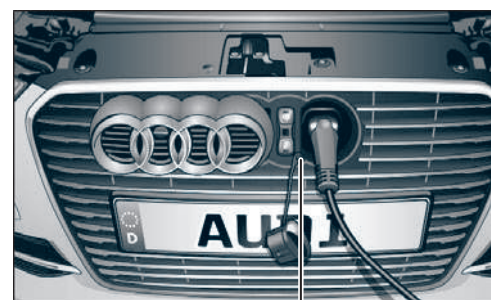

r003_123

Front charging socket

Technical fundamentals

Introduction

A hybrid vehicle (HEV) is driven by a combination of a combustion engine and an electric motor supplied with current from a high-voltage battery.

The electric motor supports the combustion engine in acceleration phases and is used as a generator in braking phases in order to charge the high-voltage battery (recuperation).

With plug-in hybrids (PHEV), the high-voltage battery can also be charged via the socket.

Audi A6 quattro TFSIe as an example of a hybrid vehicle (HEV)

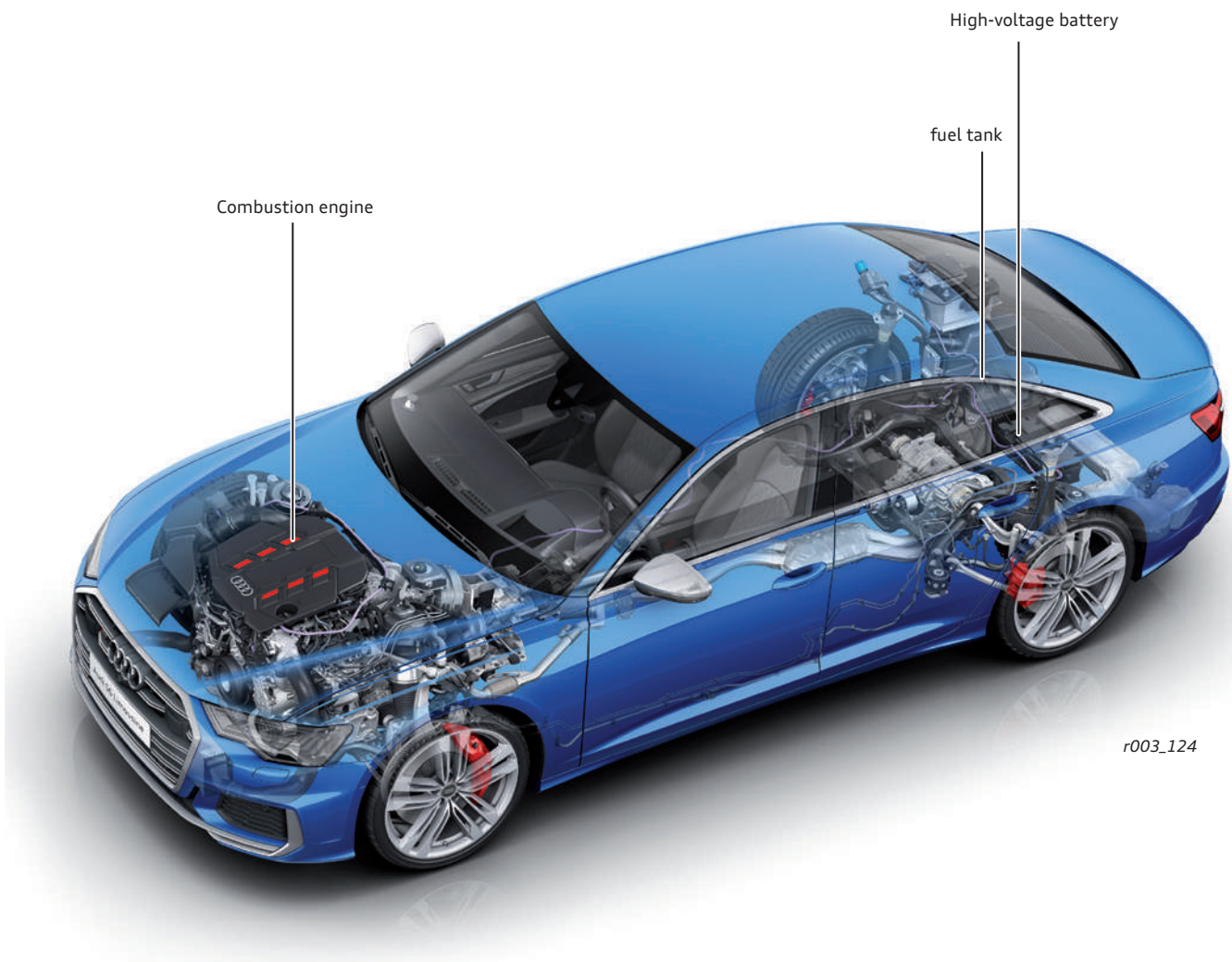

r003_124

In addition to the classic lead-acid battery, mild hybrid vehicles (MHEVs) have an additional lithium-ion battery (12 volts or 48 volts) and a starter generator. In principle, this allows functions such as extended recuperation and support of the combustion engine by the electric motor (recuperation power up to 12 kW). The drive and the generation of electrical energy is basically carried out by the combustion engine. All units work together with a belt-driven starter-generator. Purely electric driving is not possible with the Audi MHEV.

- ▶ There are no external differences between Audi mild hybrid vehicles (MHEVs) and conventional Audi vehicles.
- ▶ 48 volt lines can be identified by their colour, which is purple. Vehicles with 48-volt technology may have subsystems installed that operate in the high-voltage range (alternating current greater than 30 volts). If this is the case, the cables to these system components can be identified by orange warning colour.

Audi Q8 as an example for a mild hybrid (MHEV)

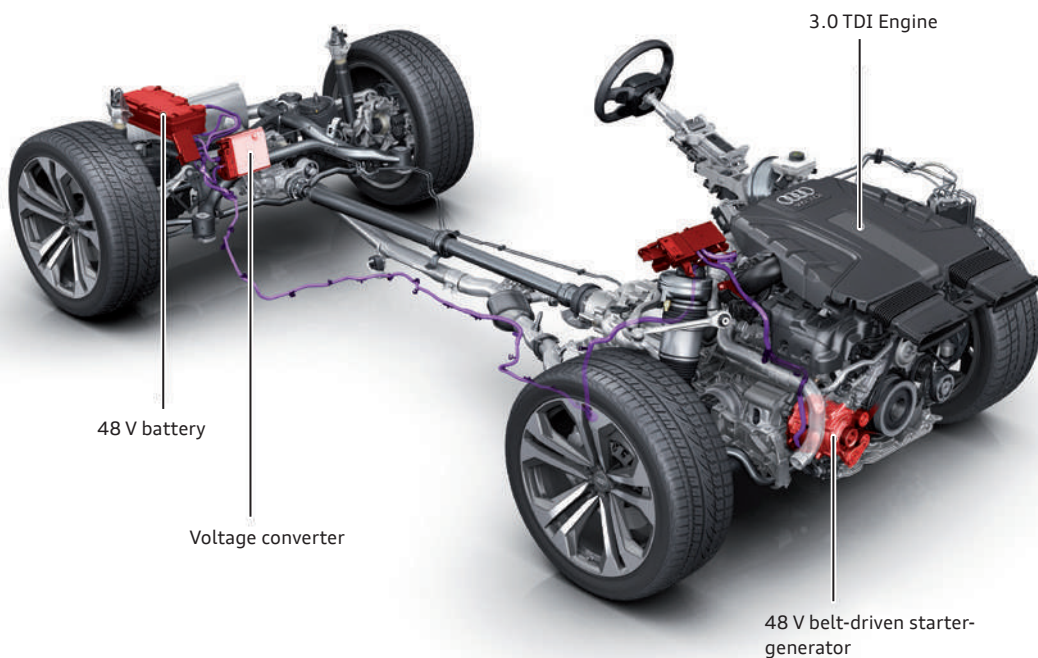

r003_125

In the case of purely electric vehicles (BEV), the drive is provided exclusively by one or more electric motors on the front and/or rear axle. Charging can take place via AC or three-phase sockets, AC wallbox charging stations or DC fast charging stations. As an optional extra, some vehicles can be equipped with a contactless charging option, with an induction plate (Audi wireless charging) located under the front engine compartment.

Audi e-tron as an example of a battery electric vehicle (BEV)

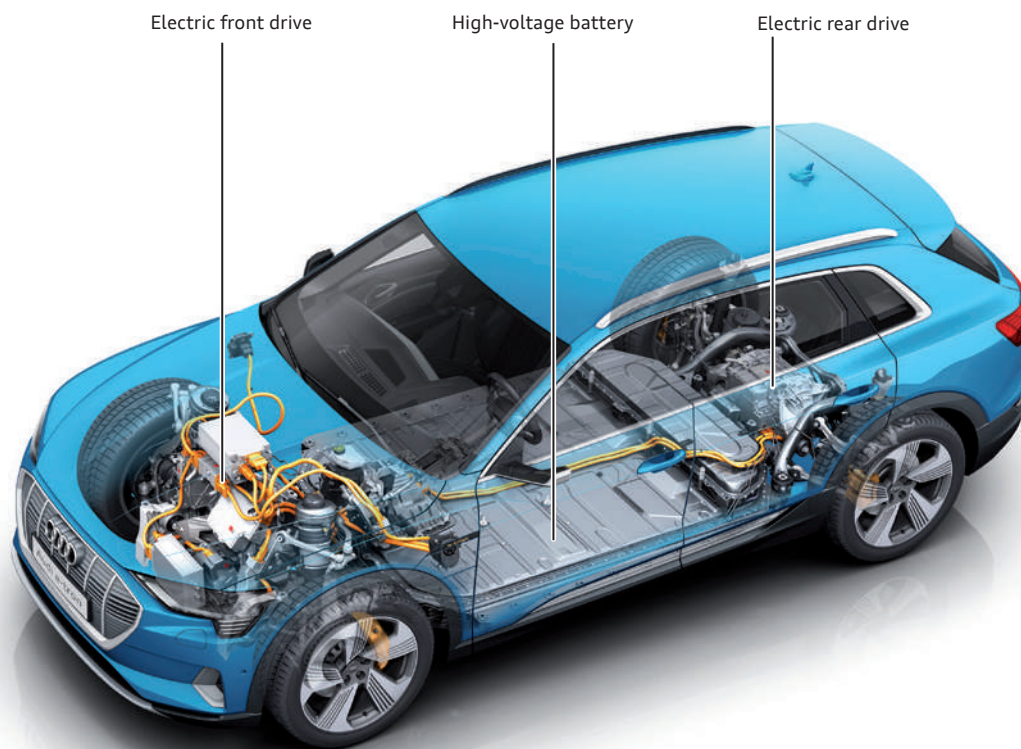

r003_126

Since purely electric vehicles (BEV) are only provided with electrical energy storage, other components of the engine, such as the coolant pump, are also electrically driven and supplied with power from the 12-volt vehicle electrical system.

Other auxiliary units, for example the air conditioning compressor are supplied from the high-voltage battery due to their high energy consumption. Thus, these auxiliary units are also counted as high-voltage components.

Audi e-tron – Overview of high-voltage components

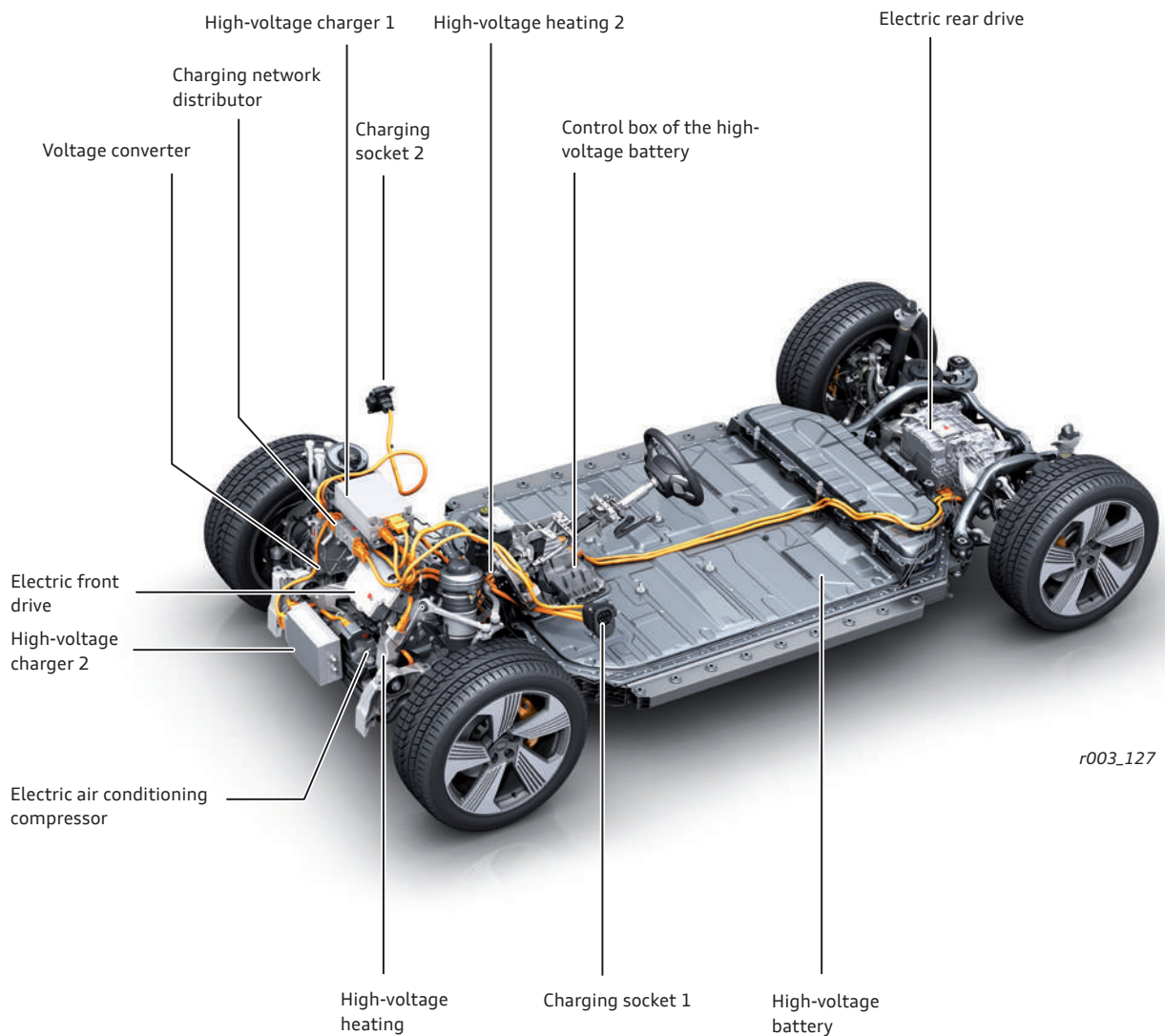

High-voltage technology

In vehicle technology, the following voltage ranges are designated as “high-voltage”:

- ▶ more than 60 V for direct current (DC) and
- ▶ more than 30 V for alternating current (AC)

The high-voltage battery, the electric motor, the high-voltage distribution and control unit, the power electronics, and some auxiliary units operate with high-voltage current.

In the following chapter, the following high-voltage components will be discussed in more detail using examples from various vehicles:

- ▶ High-voltage battery
- ▶ Power electronics
- ▶ Electric motor
- ▶ Auxiliary units e. g. high-voltage air conditioning compressor and auxiliary heater
- ▶ High-voltage cables and connectors
- ▶ Charging socket

i The listed components can also be present multiple times in a vehicle.

Schematic outline of a high-voltage system

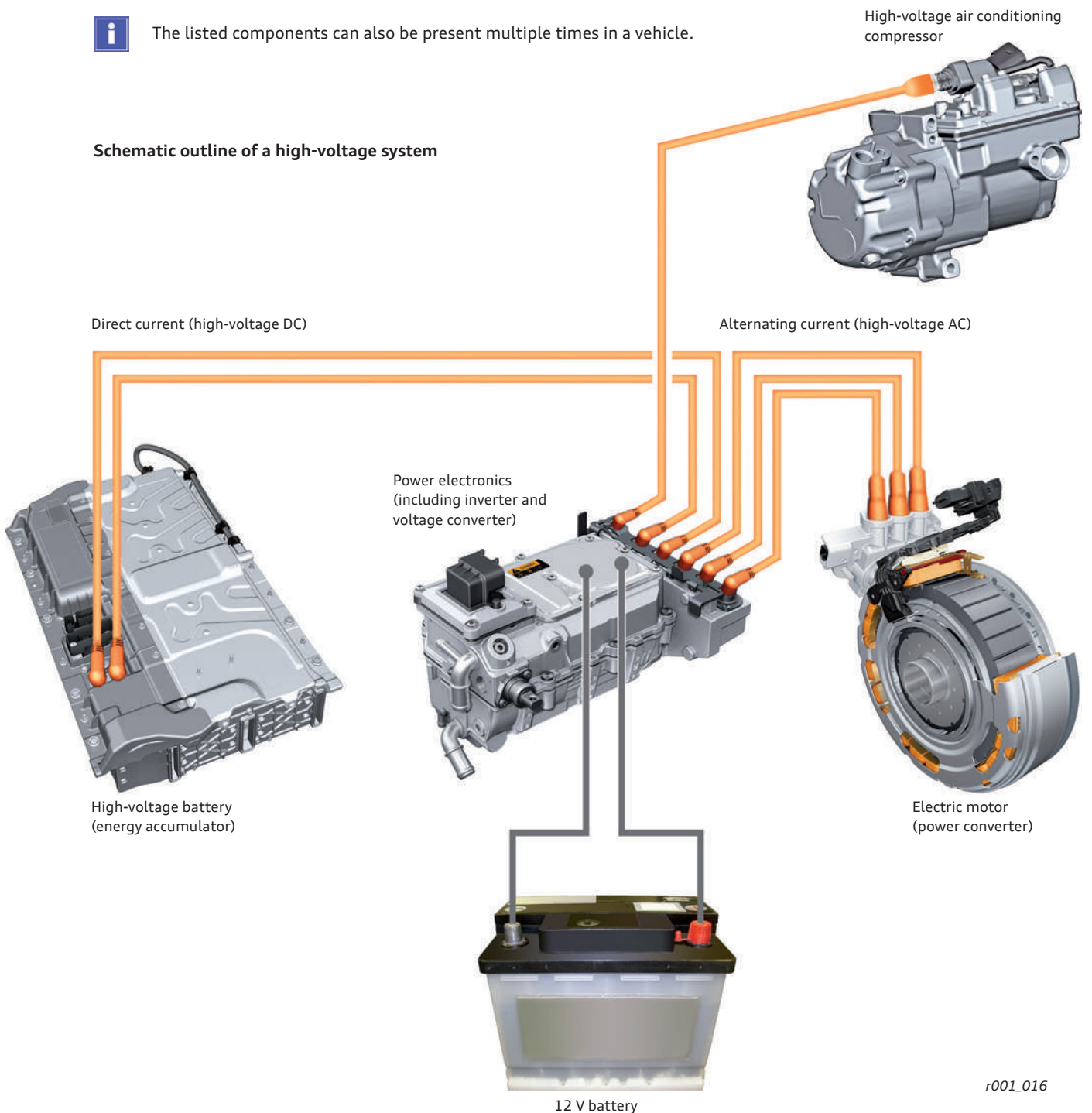

High-voltage battery

The high-voltage batteries used by Audi are lithium-ion batteries.

The high-voltage battery is arranged in a stable housing in the vehicles, in areas that are low in deformation in most crash situations.

Hybrid vehicles (HEV): The high-voltage battery can usually be found in the rear of the vehicle.

Battery electric vehicles (BEV): The high-voltage battery is usually mounted centrally under the vehicle as a load-bearing body component.

In both hybrid and battery electric vehicles (HEV and BEV), the high-voltage battery consists of battery cells connected in series, which are interconnected to form modules. Several modules are installed, along with the peripherals, in a metal casing. A potential equalisation line connects the casing to the vehicle.

Depending on the vehicle variant/equipment, the high-voltage battery may consist of several packages.

High-voltage batteries are cooled during operation. Cooling can be carried out with air or liquid and also has the task of compensating the temperature differences between the individual cells.

The control box of the high-voltage battery is either integrated in the high-voltage battery or is located directly on the high-voltage battery. The high-voltage battery is connected to the high-voltage system via the control box. In the event of a crash with belt pretensioner and/or airbag deployment, the control box immediately and automatically disconnects the high-voltage system from the power supply (see "Discharge of residual voltages" on page 25).

Battery system including control box based on the example of the Audi e-tron

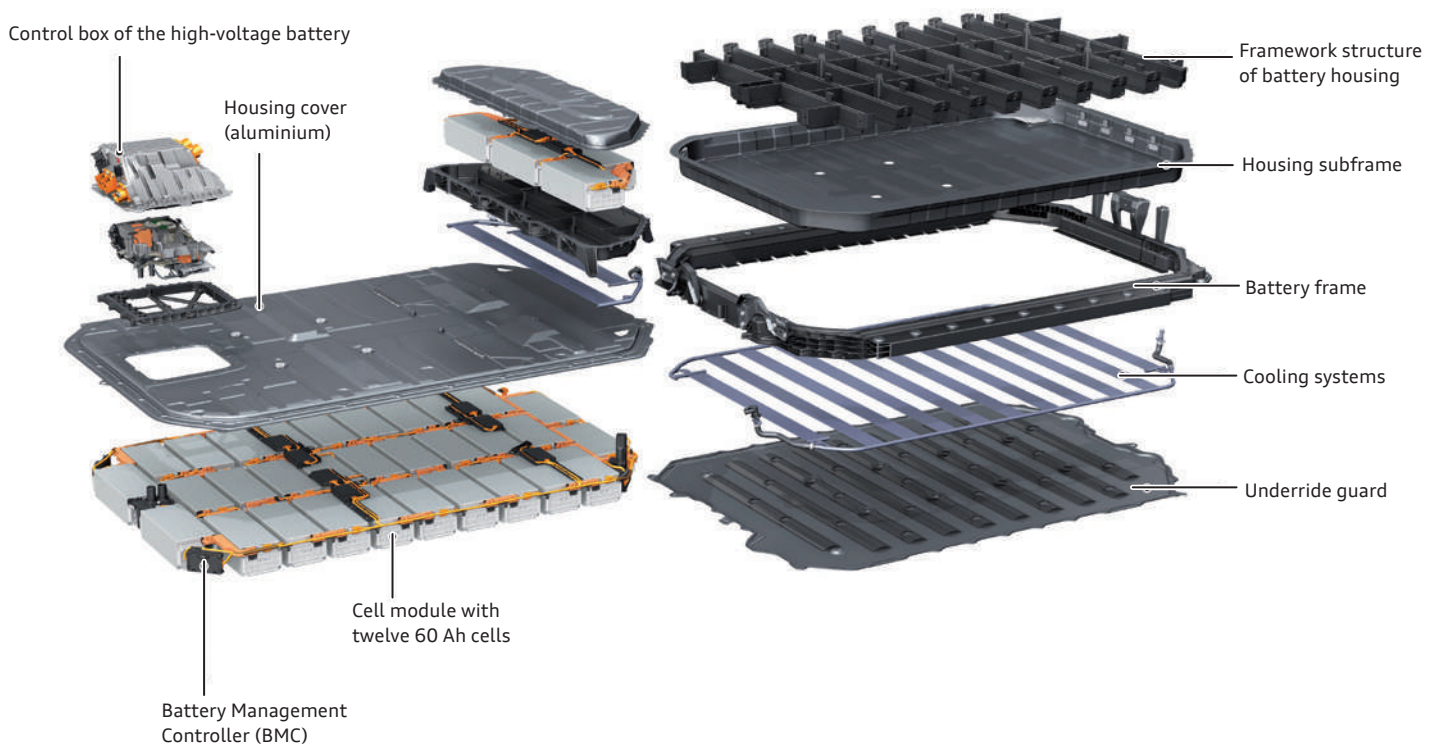

r003_128

The airbag control unit is wired to the high-voltage battery interlock in the control box. In the event of a serious collision, the airbag control unit sends signals to the contactor switch. The control box causes the high-voltage battery to switch off.



If the high-voltage battery has been switched off by a collision, it can only be reactivated by the workshop.

Control box of the high-voltage battery based on the example of the Audi e-tron

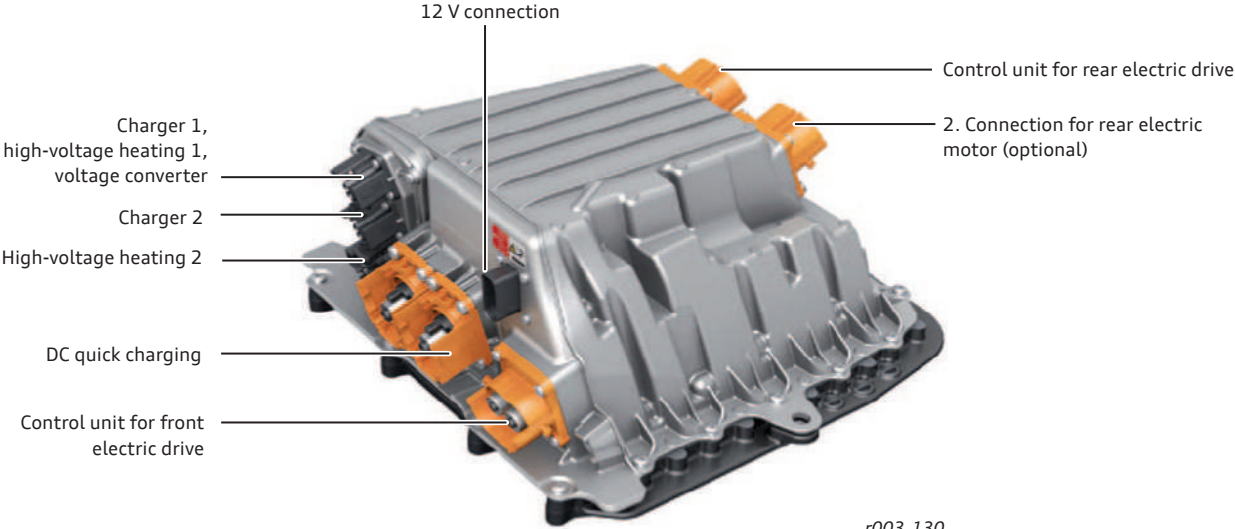

r003_130

High-voltage battery with liquid cooling based on the example of the Audi e-tron

The power electronics are connected to the low temperature cooling circuit at the front and the rear axle. This results in adequate cooling of the individual components inside the power electronics.

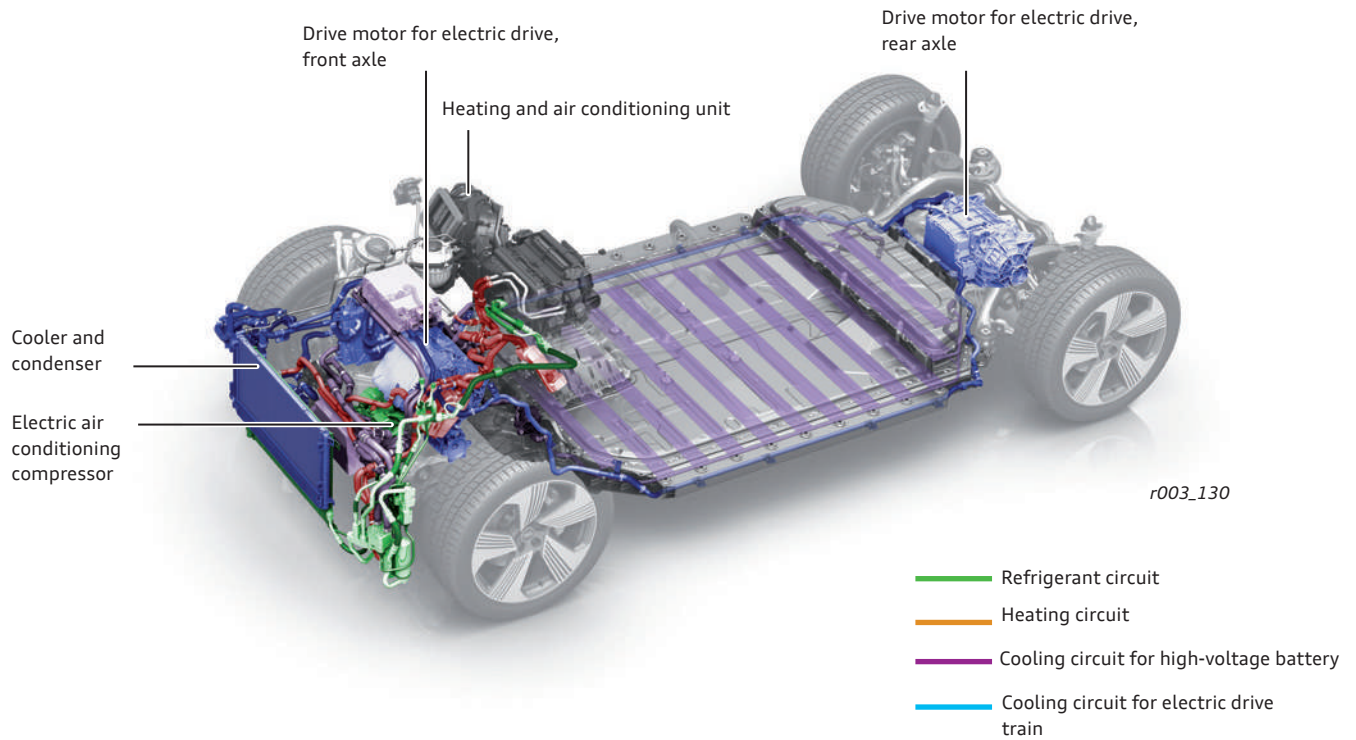

Air-cooled high-voltage battery based on the example of the Audi Q5 hybrid quattro

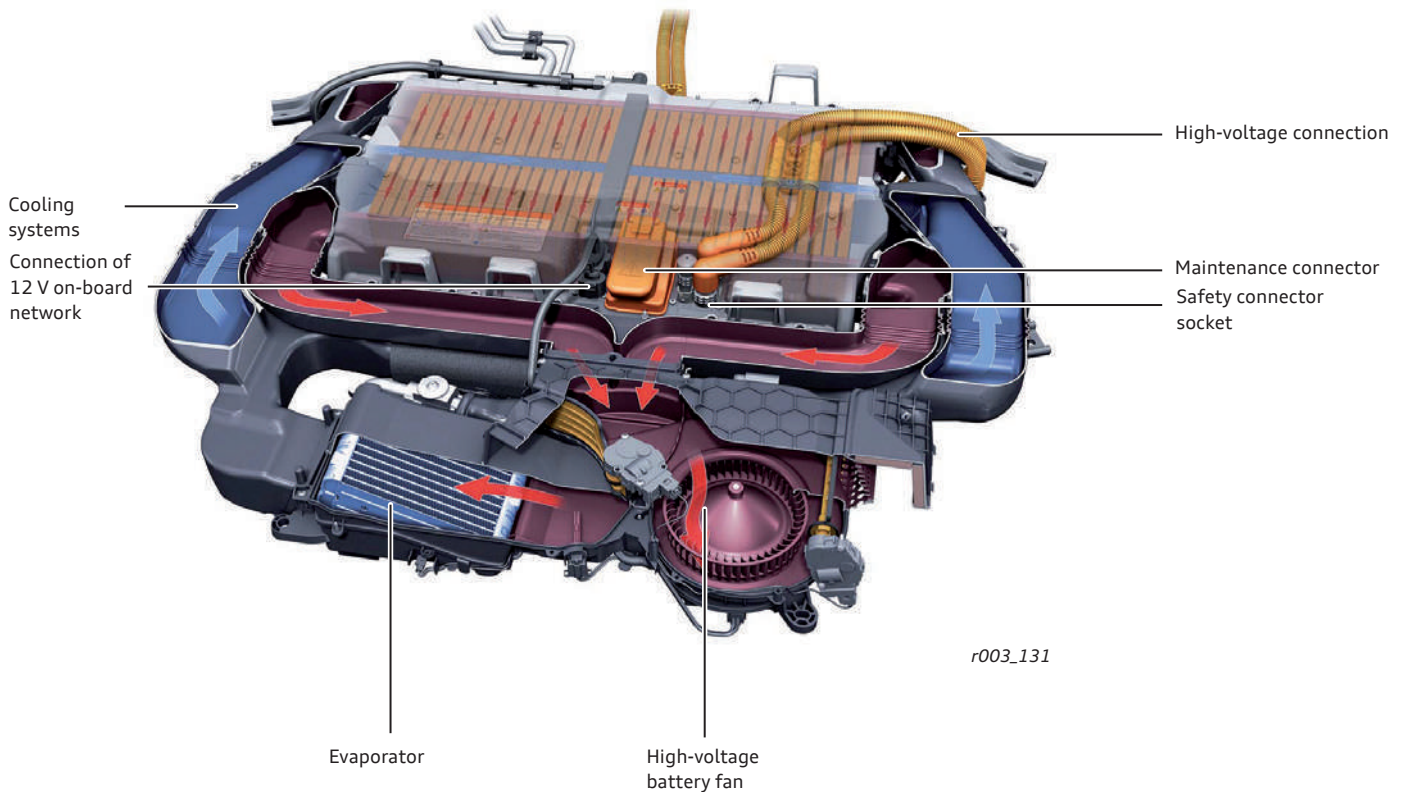

High-voltage cables and connectors

The cables with the associated high-voltage connectors connect the high-voltage battery to the other high-voltage components in the engine compartment, as well as the high-voltage components to each other. For example:

- ▶ Control unit for electric drive (power electronics)
- ▶ Electric motor
- ▶ Air conditioning compressor
- ▶ High-voltage heating
- ▶ Charger
- ▶ Voltage converter

The high-voltage cables are installed outside of the passenger compartment, i. e. they are underneath the vehicle or in the engine compartment.

All high-voltage cables and the plugged high-voltage connections have an orange coloured insulation in the visible areas. Furthermore, additional covers and hoses protect the high-voltage cables against damage. In contrast to the 12 V on-board network, the high voltage system is electrically isolated from the vehicle chassis.

High-voltage cables based on the example of the Audi Q7 e-tron

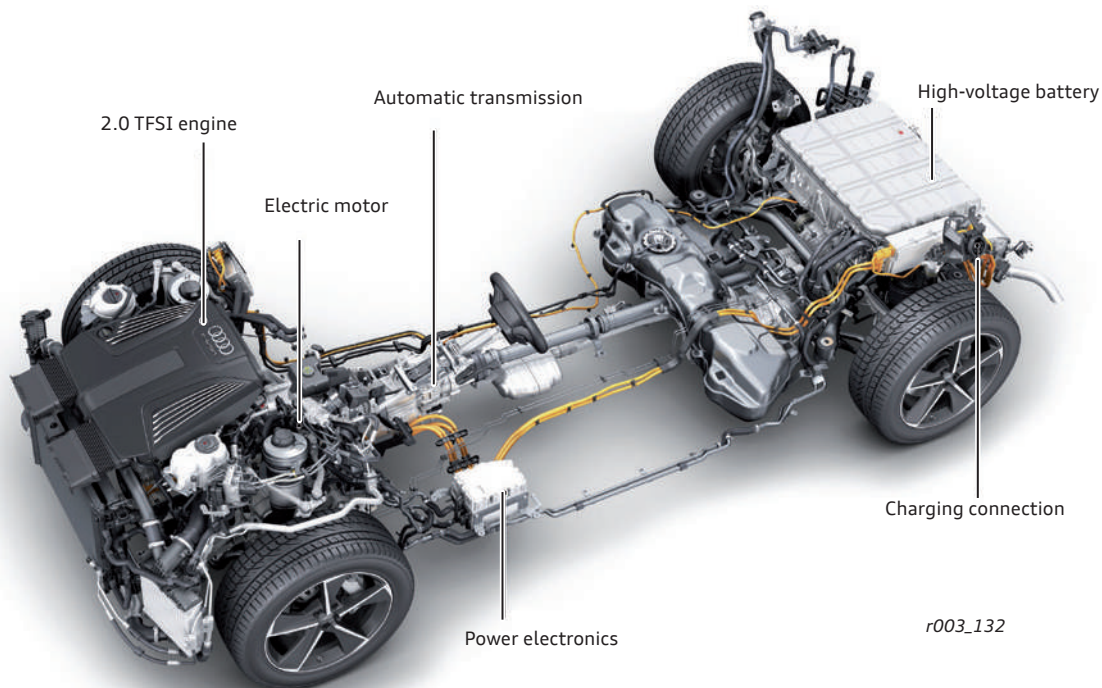

High-voltage components

Control unit for electric drive (power electronics)

The control unit for the electric drive (power electronics) has the task of providing the electric motor with the necessary three-phase current. In battery electric vehicles (e. g. Audi e-tron) the power electronics are directly attached to the electric motor and electrically contacted via three phases. Inside the power electronics, the direct current provided by the high-voltage battery is converted into three-phase current.

Example of the power electronics of the Audi e-tron

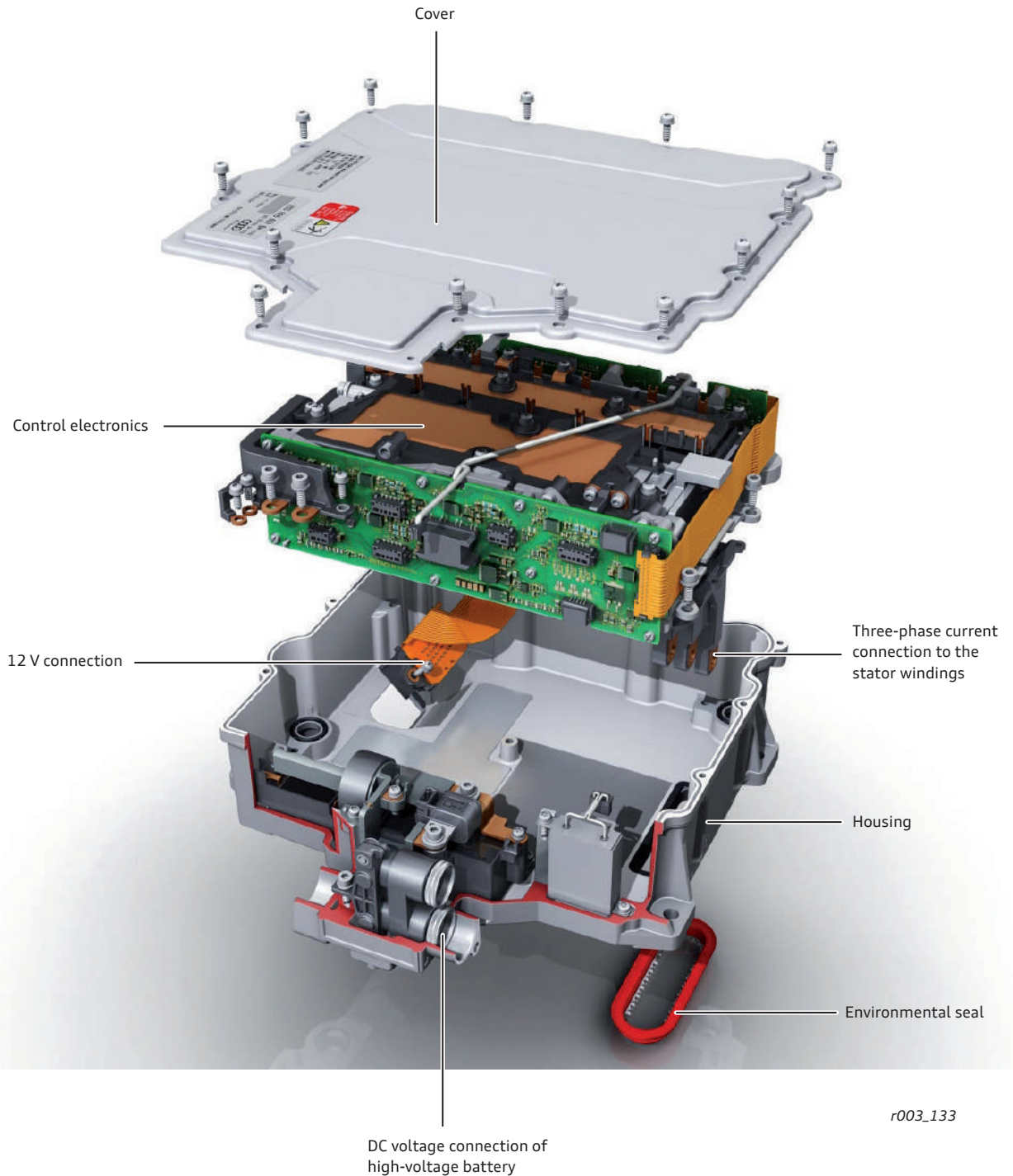

r003_133

Electric motor

In hybrid vehicles (HEV), the electric motor is located between the combustion engine and the transmission and provides additional power to the drive. The electric motor replaces the conventional starter of the combustion engine as well as the conventional generator (alternator) and serves to charge the high-voltage battery.

The operating status of the electric motor is controlled by the engine control unit and the power electronics system in order to manage the efficiency and power of the drive.

If, for example, the motor control unit detects that the power of the electric motor is sufficient for driving the vehicle, the combustion engine is switched off.

With battery electric vehicles (BEV), the complete drive and recuperation is performed by the electric motor.

Electric motor based on the example of the Audi Q7 e-tron

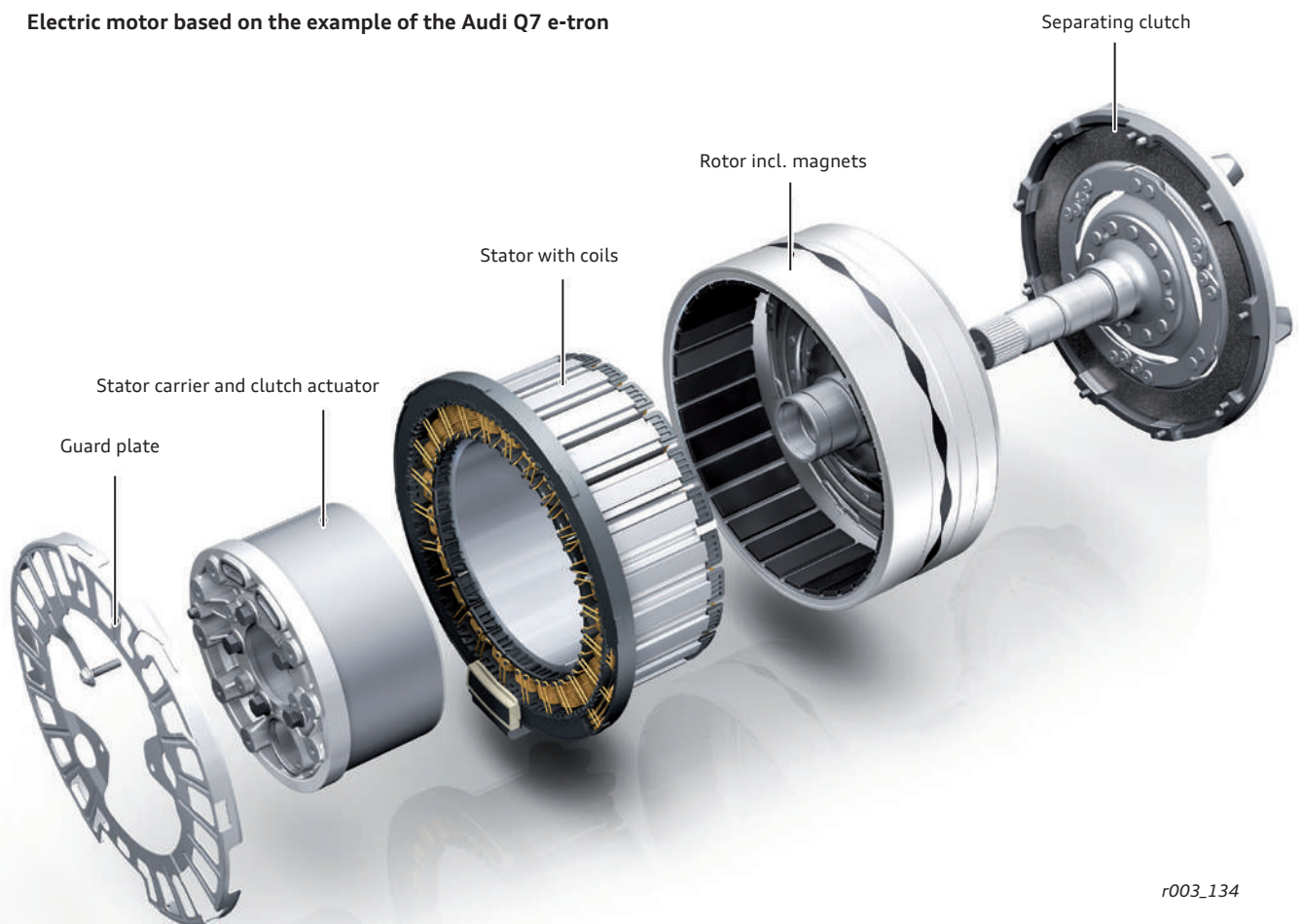

r003_134

Electric motor based on the example of the Audi e-tron

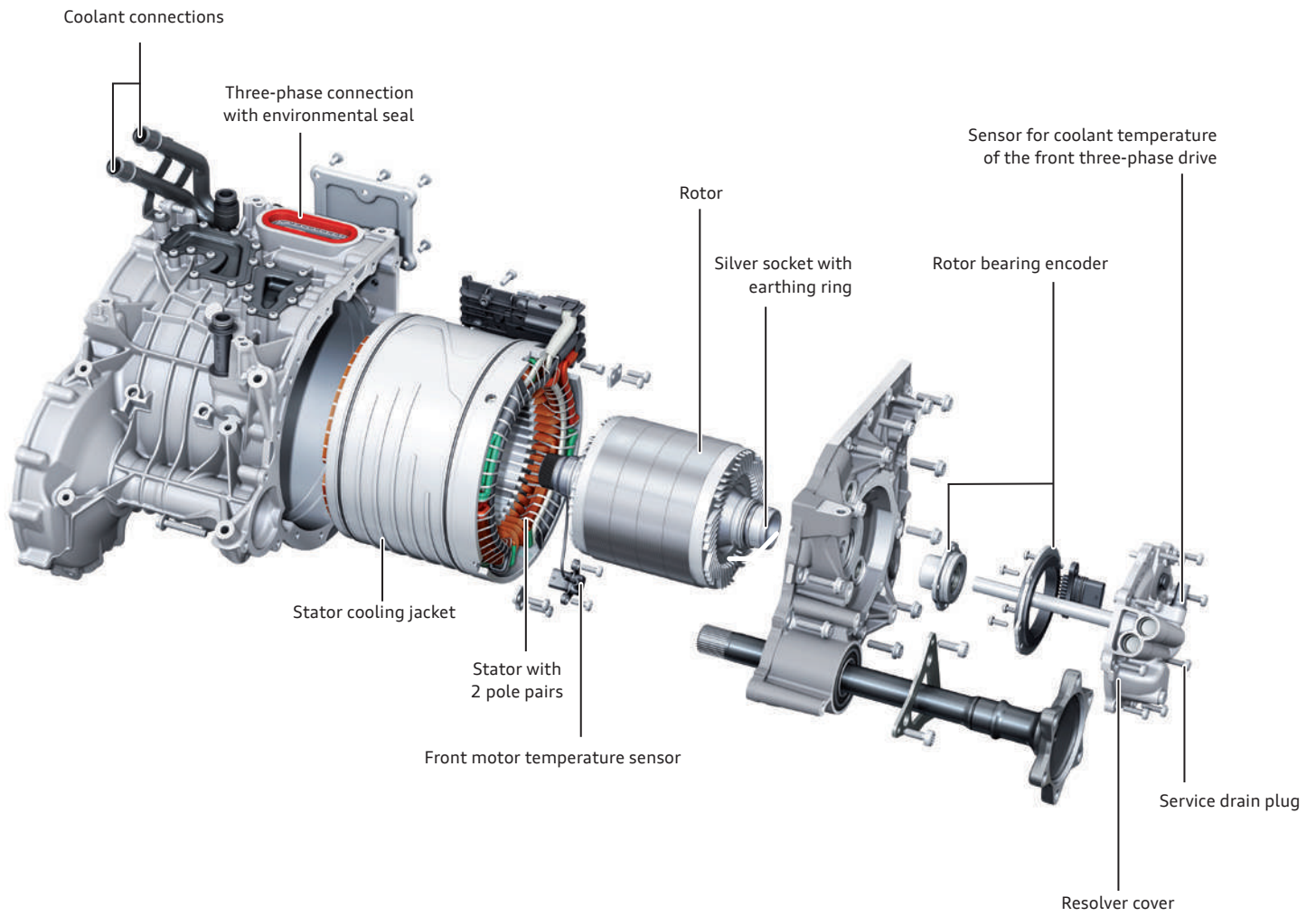

r003_135

High-voltage air conditioning compressor

The electric air-conditioning compressor is integrated into the high-voltage system. A high-voltage cable connects it to the high-voltage system of the electric drive.

The function of the electric air-conditioning compressor is to cool both the passenger compartment and if necessary the high-voltage battery when the vehicle is in electric operation or stationary.



With active stationary conditioning, the high-voltage system is active and the high-voltage components are live.

High-voltage air conditioning based on the example of the Audi e-tron

High-voltage cable connection

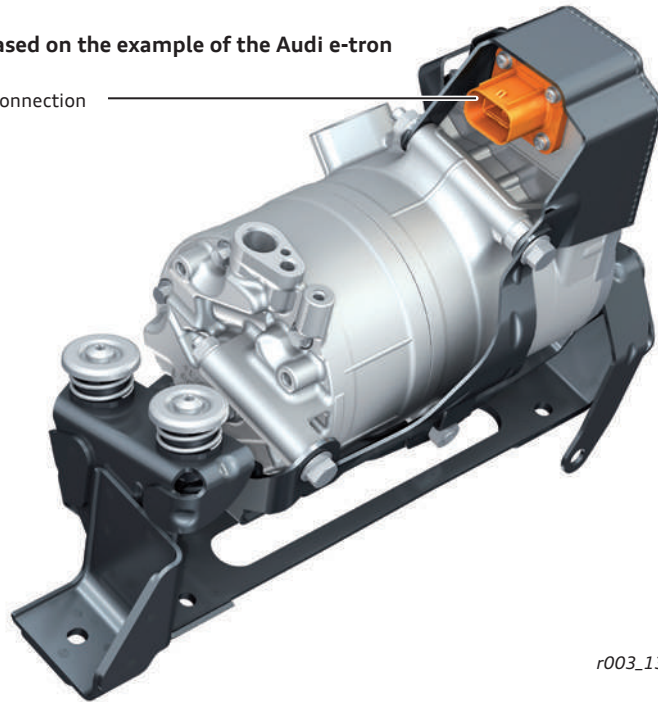

r003_137

High-voltage heating

A further auxiliary unit in the high-voltage system is the high-voltage heating.

The function of the high-voltage heating is to heat both the passenger compartment and if necessary the high-voltage battery when the vehicle is in electric operation or stationary.



With active stationary conditioning, the high-voltage system is active and the high-voltage components are live.

High-voltage heating based on the example of the Audi e-tron

12 V connection

High-voltage cable connection



r003_138

Charger for high-voltage battery

The charger is usually installed in the front or rear near the charging socket. Battery electric vehicles (BEV) can also have several chargers and thus several charging sockets.

The charging currents are transferred to the high-voltage system via induction into coils (galvanic isolation). This means that there is no conductive connection between the AC network and the high-voltage system in the vehicle.

Charger for high-voltage battery based on the example of the Audi e-tron

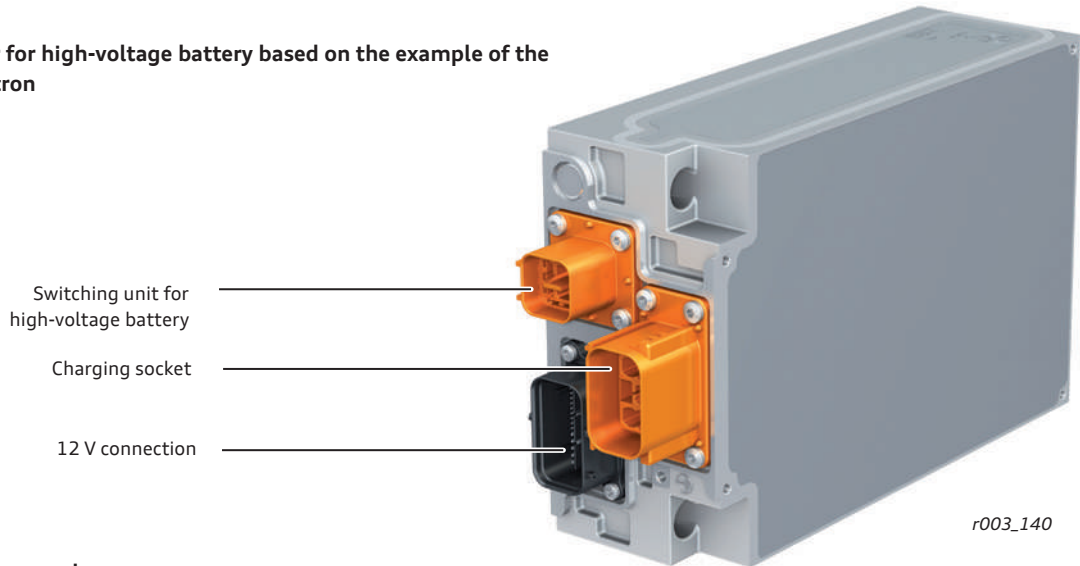

Voltage converter

The voltage converter converts the DC voltage of the high-voltage battery into the 12-volt DC voltage of the vehicle electrical system. The transmission takes place via induction into coils (galvanic isolation). This means that there is no conductive connection from the high-voltage system to the 12-volt vehicle electrical system. The power of the voltage converter is up to 3 kW. If the vehicle is stationary for a longer period of time, the 12-volt-battery is charged by the high-voltage battery if the latter is sufficiently charged.



This charging process starts automatically. The high-voltage system is active and the high-voltage components are live.

Voltage converter based on the example of the Audi e-tron



High-voltage safety concept

The electric components in the vehicle, for example the power electronics the electric motor, the high-voltage battery and the auxiliary units, such as the electric air conditioning compressor, work in voltage ranges above 60 V direct current. They are connected to high-voltage lines which are orange in colour, since the voltage level and the hazard potential is higher compared to the usual direct voltage (DC) of conventional vehicles, which is above 12 or where applicable 48 volts.

All cables with AC voltage over 30 volts can also be identified by the orange warning colour.

If an insulation fault occurs, for example due to external damage, it is detected by the system; the range of reactions extends from the mere display of an insulation fault to the shutdown of the entire high-voltage system.

In case of improper handling, the voltage in the high-voltage system poses a potential danger. Thus, there is a comprehensive safety concept for the vehicle.

The following chapter explains the essential principles of the safety concept.

- ⚠ In case of improper handling of high-voltage components and high-voltage lines, there is danger to life due to the high voltage and the possible flow of current through the human body.
- ⚠ There is still voltage in a high-voltage battery even after the deactivation of the high-voltage system. The high-voltage battery must neither be damaged nor opened. Touching it can be fatal!
- ⚠ When working with hydraulic rescue systems, when lifting, securing, towing or pulling the vehicle, the position of the high-voltage components and high-voltage cables must be observed (see vehicle-specific rescue data sheet).
- ⚠ Do not touch damaged high-voltage components and/or high-voltage cables!
- ⚠ It cannot be guaranteed that all independent protective measures will work after an accident.

Galvanic separation

The high-voltage system is galvanically separated from vehicle earth. That means that there is no direct electric connection between active parts of the high-voltage system and the car body.

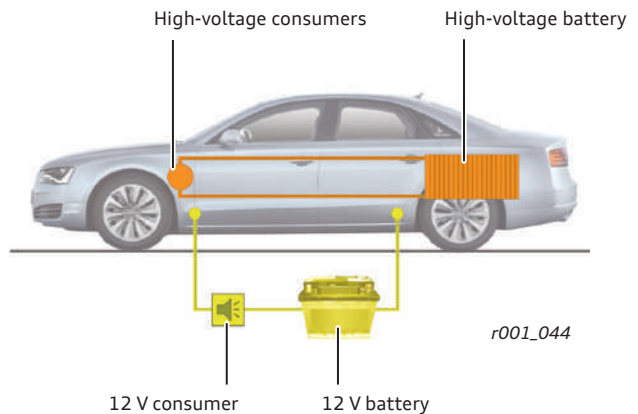

Physical protection

The entire high-voltage system is isolated from the 12 V network and the bodywork and is designed to provide protection against physical contact.

Equipotential bonding

The metal housings of all high-voltage components are conductively connected to the body. This ensures that no hazardous touch voltage can occur on the metal housing even in the event of a fault.

High-voltage cables

All high-voltage cables are provided with orange-coloured insulation. Their orange-coloured sheathing conveys a clear optical signal. Furthermore, additional covers and hoses protect the high-voltage cables against damage.

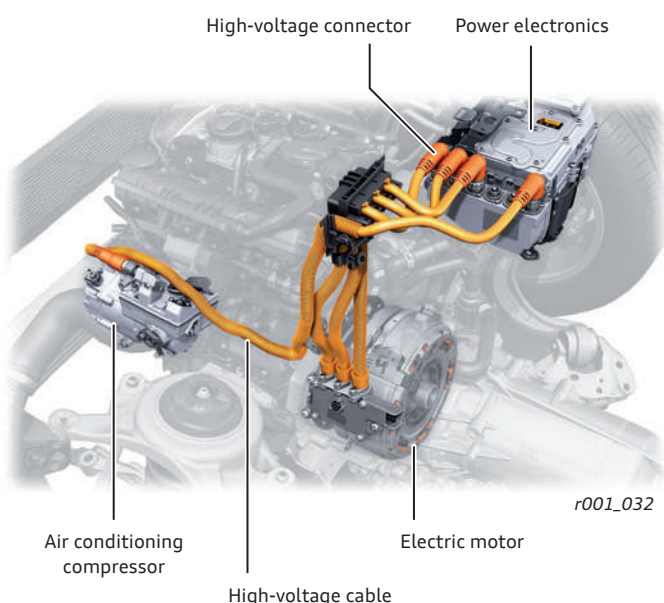

Short-circuit detection

In the event of a short circuit or overcurrent, the overcurrent protection device (fuse) is tripped and interrupts the current flow.

Discharge of residual voltages

In case of an accident with airbag and/or belt pretensioner activation or after an unexpected malfunction, the discharge circuit ensures that the high-voltage system is free from voltage after approximately 20 seconds. By activating the rescue disconnection point, the high-voltage system is usually also de-energised after approx. 20 seconds (see “Deactivate high-voltage system” on page 33).

⚠ After switch-off/deactivation, the high-voltage system is de-energised after approx. 20 seconds!

Isolation monitoring

The isolation resistance of the high-voltage system is periodically tested for isolation monitoring, i. e. for monitoring whether the high-voltage system is disconnected from the bodywork. Malfunctions are indicated with a warning message to the driver, by the lighting of a yellow lamp in the instrument cluster, and an acoustic signal.

Disconnection in case of a crash

Both battery poles are equipped with protection relays (contactors) which are closed for the operation of the high-voltage system. In case of an accident with airbag or belt pretensioner activation, the high-voltage battery receives a crash signal to open the protection relays. The protection relays of the high-voltage battery open and the high-voltage system outside the battery discharges (see “Discharge of residual voltages” on page 25). The high-voltage connections of the high-voltage battery and all high-voltage components will then be voltage-free. Beyond the automatic crash deactivation, the vehicle specific rescue data sheets of mild hybrid vehicles (MHEV), hybrid vehicles (HEV) and battery electric vehicles (BEV) contain information about how to deactivate the high-voltage system and the vehicle itself.

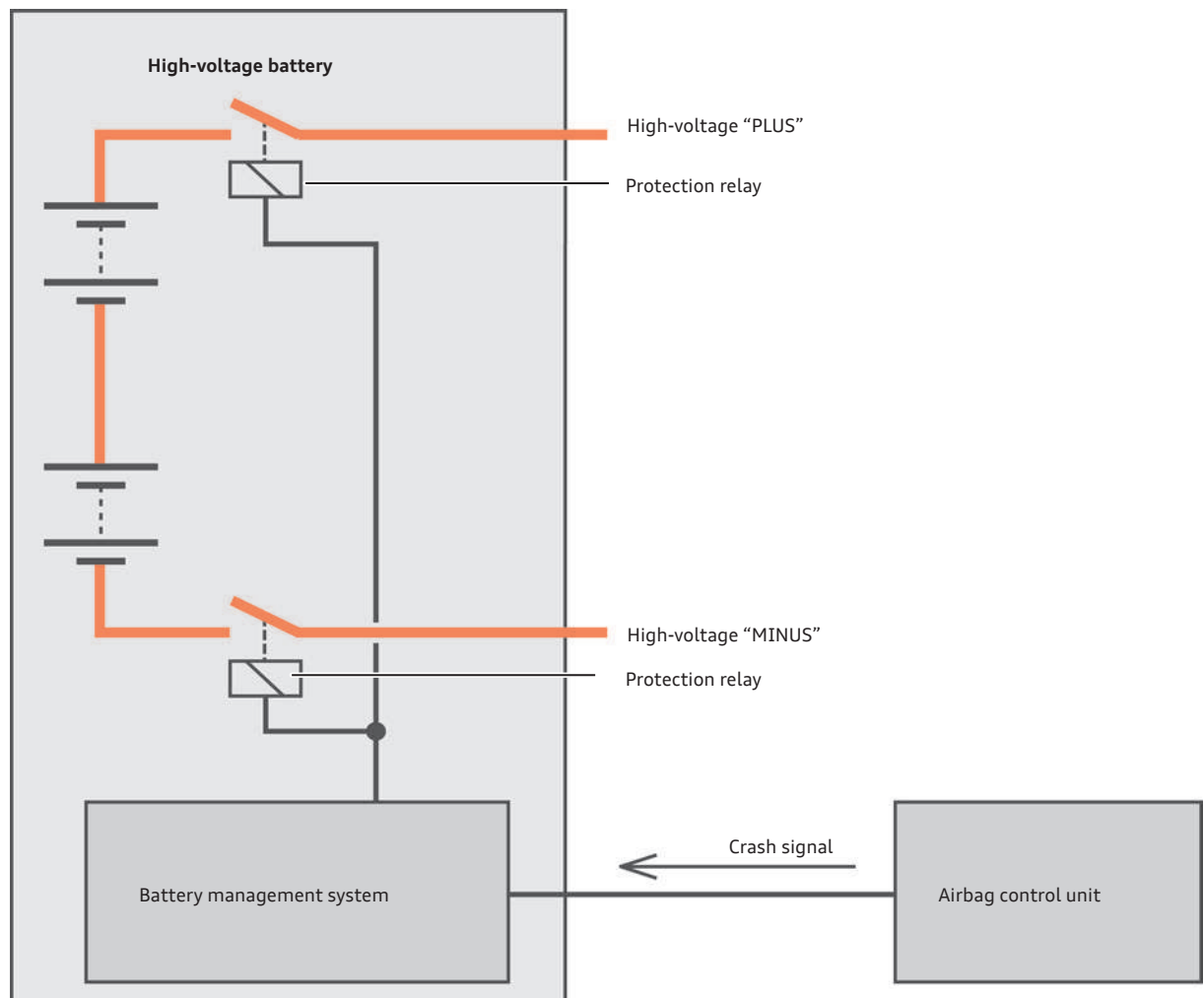

Warning labels

All high-voltage components (except for high-voltage cables) are marked with explicit warning labels.

The basic warning labels types are shown below.

- ▶ The warning labels with the lettering “Danger” directly mark the high-voltage components.

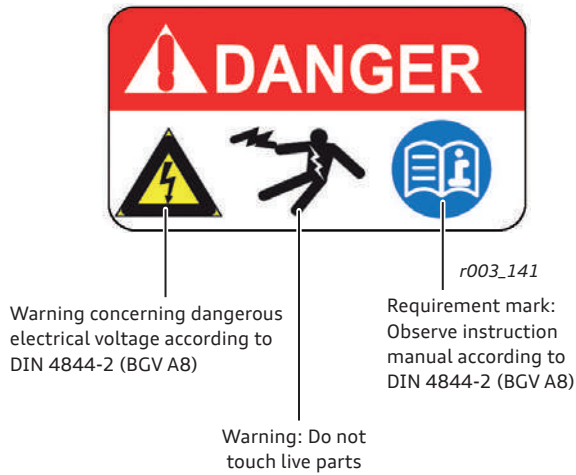

- ▶ Yellow warning label with the electrical voltage warning sign

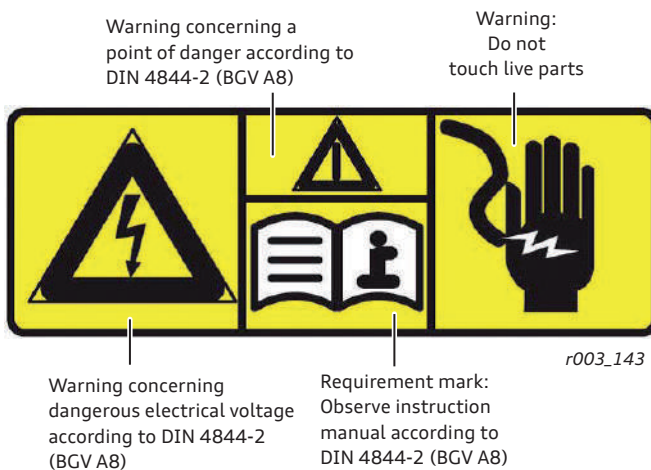

► The high-voltage battery is identified by a larger label with corresponding warning notes.

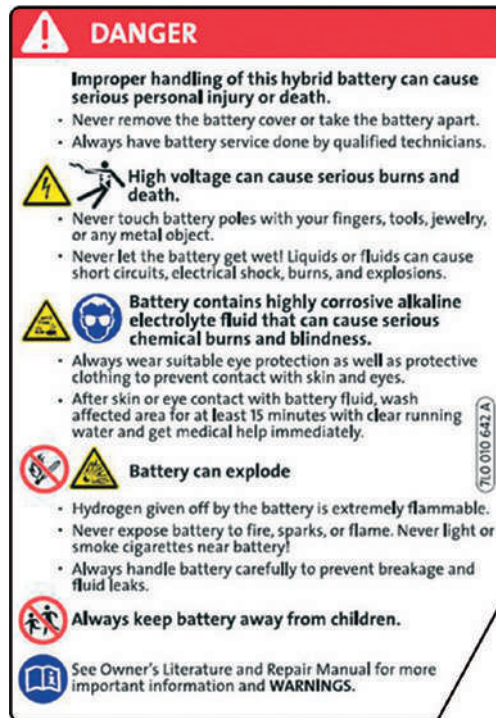

r001_023

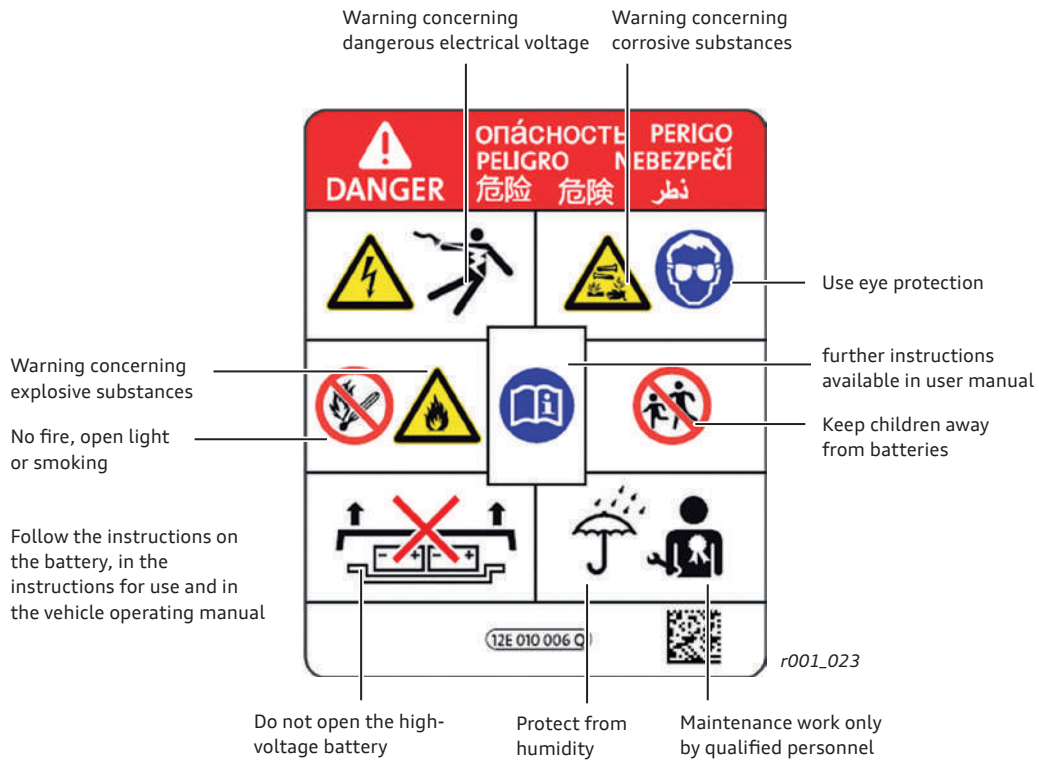

r001_023

Notes for the rescue work

The handling of mild hybrid vehicles (MHEV), hybrid vehicles (HEV) and battery electric vehicles (BEV) involved in accidents differs in some respects from the handling of petrol or diesel vehicles, e. g. high voltages, lithium-ion battery.

Knowledge about these differences can be important for the rescue work after car accidents.

Readiness for operation



It can be difficult to determine readiness for operation from the operating noises, because the electric motor is noiseless.

The pointer of the power meter indicates the current load on the drive; it is usually located on the left-hand side of the instrument cluster. The drive is active if the power meter in the instrument cluster shows READY (usually the 9 o'clock position). An inactive drive can be recognized by the power meter in the instrument cluster being set to "OFF" (for older Audi models "6 o'clock" position, for newer Audi models "half past 8 o'clock" position; see power meter display in the example pictures).

As long as the display in the power meter is not set to "OFF", electric motor operation or an automatically starting combustion engine can still be expected.

The section Technical Assistance (see "Technical assistance" on page 29) describes the process for immobilizing and deactivating hybrid and electric vehicles.

Example: older Audi models

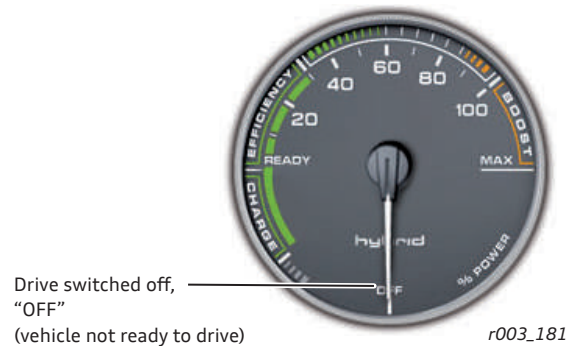

Example: newer Audi models

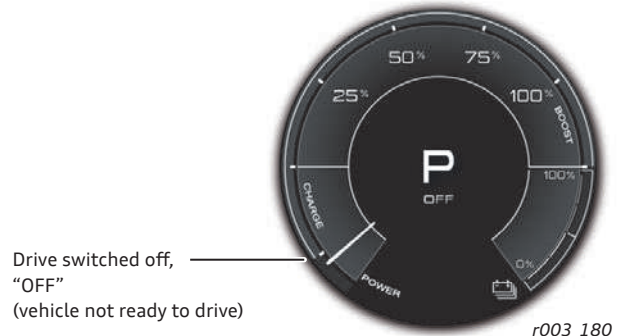
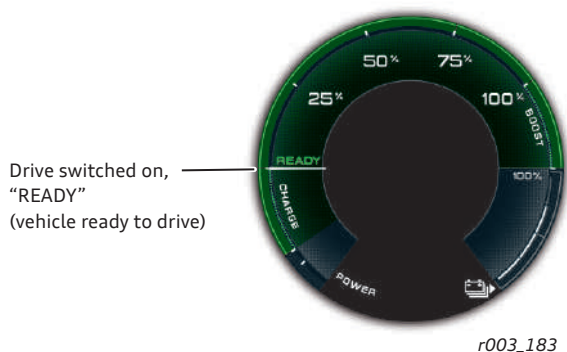

Technical assistance

Due to the high-voltage safety concept (see on page 24), the potential for risks from the high voltage components is mitigated. However, residual risks are still present in the event of serious accidents (e.g. with a damaged battery). Please refer to the chapter “General Safety Information on Lithium-Ion Batteries” on page 41.

In the event of an accident with belt pretensioner and/or airbag activation, the battery protection relays are opened so that the high-voltage connections of the battery system are de-energised (see “Disconnection in case of a crash” on page 25). Discharge circuits in other high-voltage components ensure that these are voltage free after approximately 20 seconds (see “Discharge of residual voltages” on page 25).



After switch-off/deactivation, the high-voltage system is de-energised after approx. 20 seconds!

The procedures of rescue services are generally regulated by corresponding laws, regulations or guidelines. In addition, further information is provided by the relevant specialist bodies or associations (see e. g. DGUV Information 205-022: Rescue and fire extinguishing work on passenger cars with alternative drive technology).

The subsequent chapters generally highlight issues which could become significant during the technical assistance after accidents involving vehicles with hybrid or electric drive.

Further information can be found in the FAQ “Accident assistance and recovery for vehicles with high-voltage systems” issued by the VDA.

Rescue data sheets

Vehicle specific features are described in the rescue data sheets.





The rescue data sheets for vehicles with alternative drive may contain additional information about the handling of the vehicle. The procedure for vehicle deactivation for these vehicles can be found in the rescue data sheets.

Apart from the indications normally included in the rescue data sheets of conventionally driven vehicles, the rescue data sheets for hybrid and electric vehicles indicate the position of the high-voltage battery, the cables between battery and engine compartment, high-voltage components, and the devices for deactivating the high-voltage system.

In addition to schematic top and lateral view (on the first page), rescue data sheets may include further pages with the following sections:

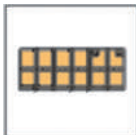
- ▶ Immobilizing the vehicle
- ▶ Switch off the ignition
- ▶ Deactivation of the high-voltage system
- ▶ Disconnect 12 V and 48 V battery/batteries
- ▶ Disconnecting the charging cables

The symbols used in the rescue data sheets applying in particular for hybrid vehicles (HEV) and battery electric vehicles (BEV) are:

Symbol	Designation	Symbol	Designation
	High-voltage battery		High-voltage cables and components
	High-voltage rescue disconnection point		Fuse box with fuse for high-voltage deactivation



The example on the following page shows the overall structure of rescue data sheet.

Immobilizing the vehicle

According to the situation, the vehicle must be stabilized by appropriate means (slings, chocks etc.).

The electric parking brake is usually located next to or behind the shift/select lever and is activated by pulling it slightly up.



Electromechanical parking brake

r003_151

For vehicles with automatic transmission, the transmission should be set to position "P" (park) using the gear lever.



Setting the gear lever to position "P"

r001_038



Transmission setting P

r003_150

Deactivation of the high-voltage system

The high-voltage system of Audi vehicles is deactivated automatically with the activation of the belt pretensioners and/or airbags.

Beyond this, the service rescue data sheets for hybrid and electric vehicles in many cases describe a separate way of deactivating the high-voltage system.

Hybrid vehicles (HEV) and battery electric vehicles (BEV) usually have a direct current converter (DC/DC) where the 12-volt system can be supported or fed in by the high-voltage system. Simply switching off the ignition and disconnecting the 12-volt battery/batteries is not sufficient for high-voltage vehicles to safely deactivate the high-voltage and 12-volt systems. In this case, the high-voltage system of such a vehicle can be switched off with one of the additional high-voltage deactivation possibilities (rescue disconnection points).

Rescue disconnection point for high-voltage system 12 V / LV (Low Voltage) Service Disconnect

The low-voltage service disconnect serves as a rescue disconnection point for the high-voltage system in plug-in vehicles (PHEV) and battery electric vehicles (BEV). The plug has a green casing and a tab for unlocking. A yellow label at the plug cable clearly indicates that this plug is a rescue disconnection point.

The plug is marked with the symbol "high-voltage rescue disconnection point" in the rescue data sheet.



Symbol „High-voltage rescue disconnection point“ in the rescue data sheet

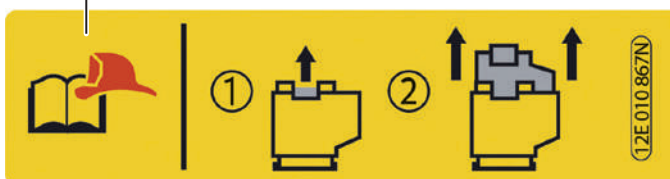
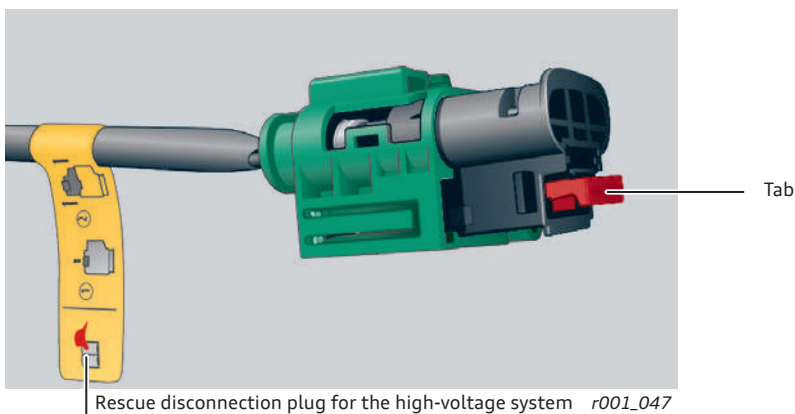

Label at the rescue disconnection plug for explaining the actuation of the high-voltage disconnection.

r001_052

Procedure for deactivating the high-voltage system by means of a rescue disconnection point

1. Locating the rescue disconnection point: see rescue data sheets
Example: location in the engine compartment

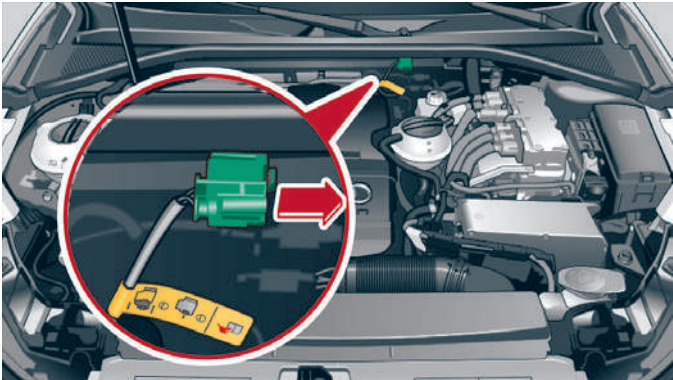

r001_050

2. Pull out the red tab of the rescue disconnection point.

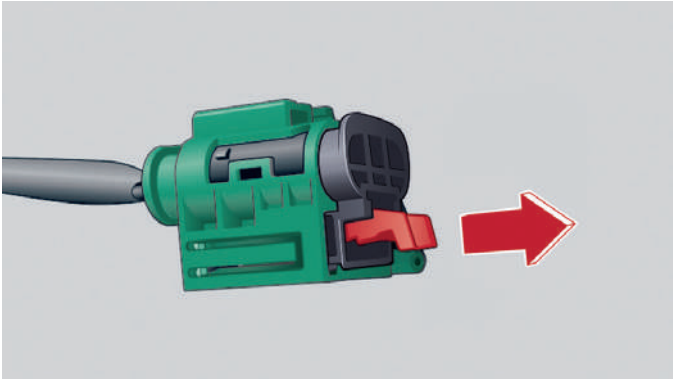

r001_089

3. Keep the red tab pressed while pulling out the black plug until it locks.

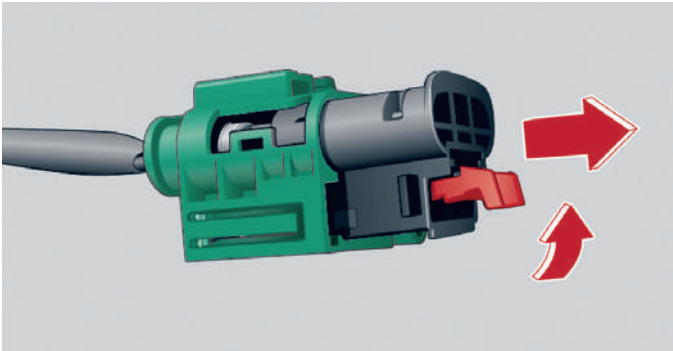

r001_090

Fuse box (additional rescue disconnection point for high-voltage system)

In order to offer an additional possibility for deactivating the high-voltage system, more recent hybrid vehicles (HEV) and battery electric vehicles (BEV) have a fuse in the fuse box.

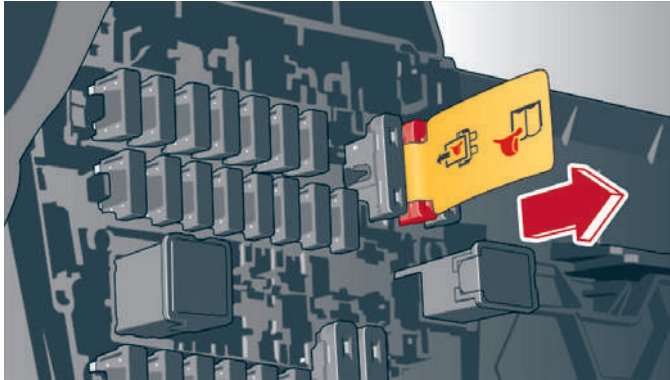

r001_053

Fuse box with a fuse for deactivating the high-voltage system.



Symbol "Fuse box with fuse for high-voltage deactivation" in the rescue data sheet

The fuse can be identified by the yellow label. It can be simply pulled out in order to deactivate the high-voltage system. The fuse box equipped with this fuse is identified in the rescue data sheet with an orange coloured fuse symbol "Fuse box with fuse for deactivation of the high-voltage system". Moreover, the rescue data sheet in this case often includes further information about the exact location and the access to the fuse box.

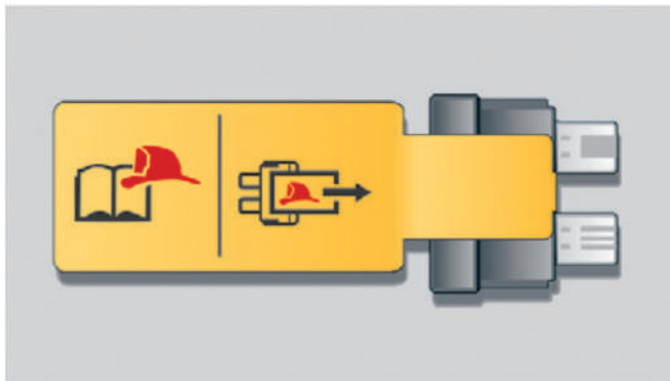

r003_153

Label on the fuse for deactivating the high-voltage system

Procedure for deactivating the high-voltage system by pulling out the fuse (example: Audi e-tron).

1. Remove the loading floor from the boot

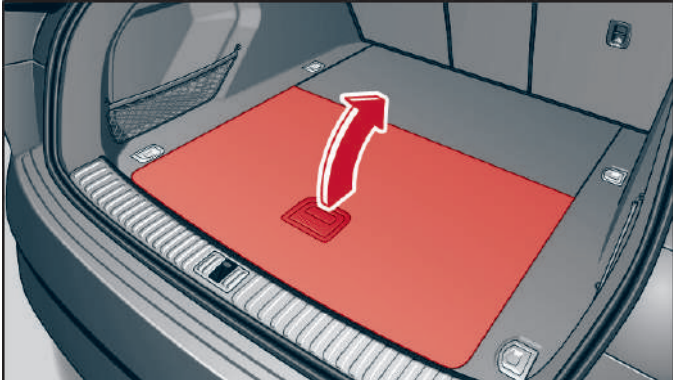

r003_155

2. Remove the fuse box cover

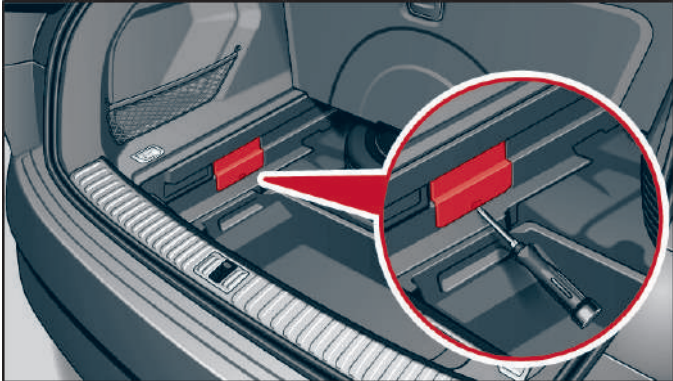

r003_156

3. Locate the fuse and pull it out

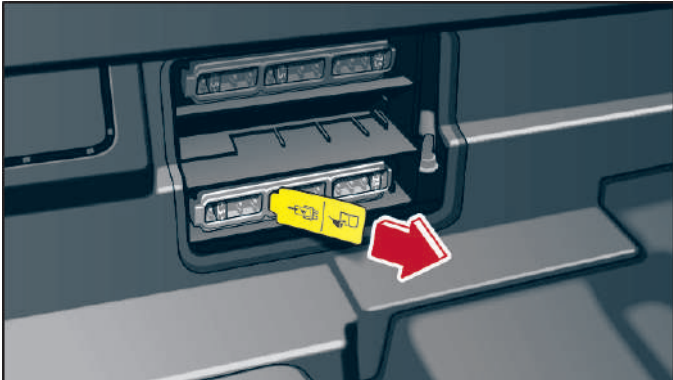

r003_157

 For locating the fuse box, please use the rescue data sheets!

High-voltage service disconnect plug for Q5 hybrid, A6 hybrid, A8 hybrid

The hybrid vehicles (HEV) Q5-hybrid, A6-hybrid, A8-hybrid have a different high-voltage service disconnect plug. This high-voltage service disconnect plug is located in the middle of the boot floor under a flap that must be opened. The orange rubber protective cap underneath that must be removed. The exact location can be found in the rescue data sheets.

The pictures show the direct operation of this high-voltage service disconnect plug. First the lever is pulled to the rear, then it is turned upwards and pulled out.

1. Pull the lever to the rear.



r001_083

2. Turn lever upwards and pull out plug in upward direction



r001_084

Disconnection of the 12 V battery/batteries

In order to completely disconnect a high-voltage vehicle from the power supply, the 12-volt lead-acid battery must be disconnected after HV deactivation.

The position of the 12 V battery/batteries can be taken from the rescue data sheet.

If the battery is to be disconnected completely, the ground/minus pole must be disconnected, otherwise there is a risk of short circuits. The negative pole must be protected against renewed contact (insulation, tying away, bending away...). If the battery is disconnected, it should be checked whether the vehicle is actually voltage-free. The extinguishing of the hazard warning lights or the interior lighting can serve as a sign. To completely disconnect a high-voltage vehicle from the power supply, the 12-volt lead battery must be disconnected after HV deactivation.



If it is necessary to disconnect the battery, it must be disconnected even if a battery disconnection element is fitted.

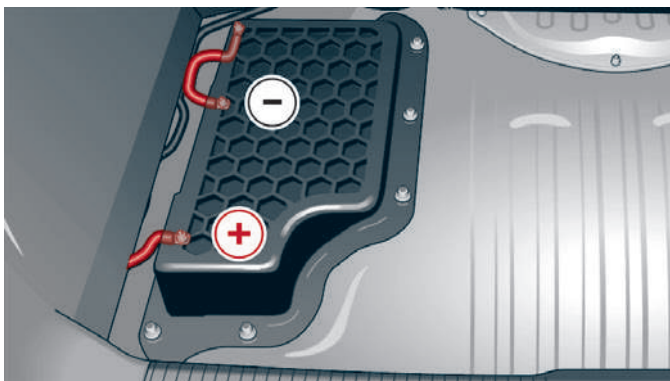

Disconnecting the battery

r001_099

Battery disconnection in mild hybrid vehicles (MHEV, 12 Volt/48 Volt)

For vehicles with 48 V on-board power supply the 48 V vehicle electrical system is automatically deactivated in the event of accidents involving belt pretensioner and/or airbag activation. The lithium-ion battery of a 12 V MHEV is also deactivated automatically in the event of accidents involving belt tensioner and/or airbag activation.

In all other cases, the lithium-ion battery (12 V or 48 V) must be disconnected in addition to the 12 V lead-acid battery in order to deactivate the on-board power supply:

 Switch off the ignition before disconnecting the batteries!

In order to reduce the hazard of an electric arc, the following procedure is recommended:

After locating the batteries (see rescue data sheet), the first step is to disconnect the negative pole of the 12-volt lead battery. In the second step should the lithium-ion battery be disconnected. In this respect, it is recommended to disconnect the communication plug before disconnecting the negative pole.

 For the 48 V lithium-ion battery, there is a residual risk of arcing when the negative pole is disconnected.

Procedure for disconnecting the 12 V and 48 V battery based on the example of the Audi A4

1. Remove the loading floor from the boot

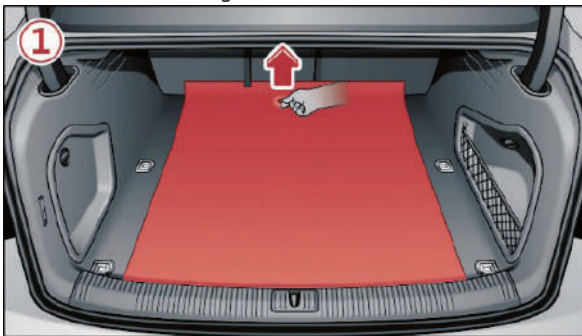

r003_158

2. Locating the batteries



r003_159

12 V lead-acid battery

48 V lithium-ion battery

3. Loosen the screwed connection of the negative pole of the 12 V lead-acid battery

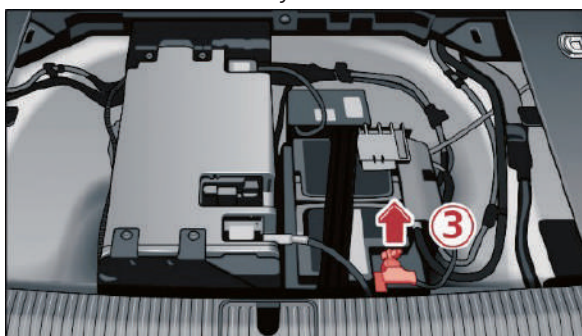

r003_160

4. Disconnect the communication connector of the 48 V lithium-ion battery

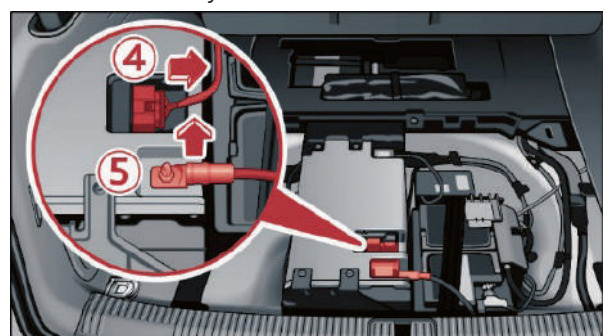

r003_161

5. Loosen the screwed connection of the negative pole 48 V lithium-ion battery

 For locating the batteries, please use the rescue data sheets!

Canceling the charging process

If a vehicle connected to a charging station is involved in an accident, the interruption of the charging process cannot be ensured.

It is recommended to ensure the interruption of the charging process by pulling the connector from the charging station. The following working steps are necessary in order to separate the charging cable from the vehicle.

Example: Audi e-tron

1. Unlocking the vehicle (e. g. via the radio key)

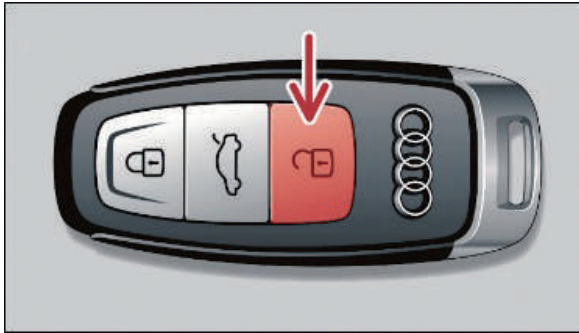

r003_162

2. Press the button on the charging socket and disconnect the charging cable from the vehicle

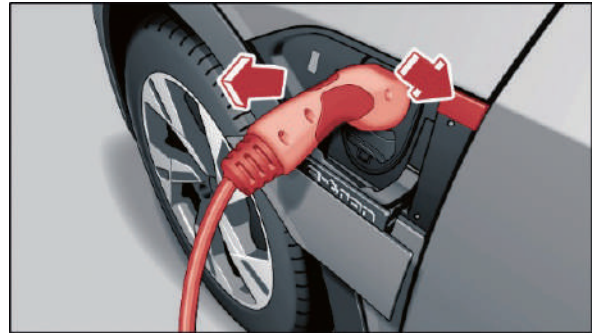

r003_163

Charging procedure emergency unlocking

The new Audi models also feature a charging plug emergency release. The respective procedure is described in the rescue data sheets.

Procedure for charging plug emergency unlocking based on the example of the Audi e-tron

- ▶ Open the front flap
- ▶ Open cover 1 in the engine compartment on the relevant charging side
- ▶ Remove the yellow loop 2 from the support and pull it carefully
- ▶ Disconnect the charging plug

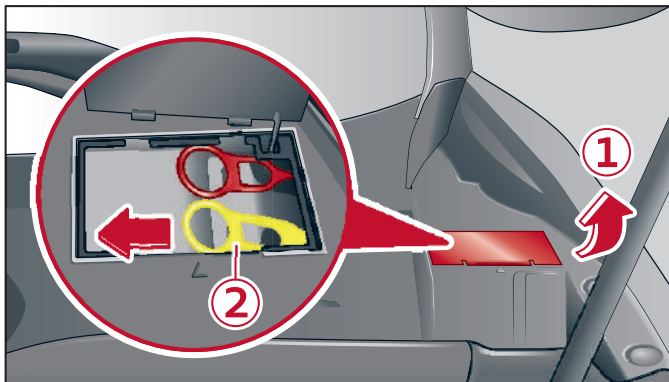

r003_164

Locking and unlocking the vehicle

The current Audi models apply various techniques for locking and unlocking the vehicle.

- ▶ Radio key: Unlocking by pressing a button on the corresponding symbol of the radio key.
- ▶ Comfort key: Unlocking by touching the sensor on the door handle; for this, the comfort key must not be more than approx. 1.5 m away from the door handle.
- ▶ Connect key: Mobile phone of the vehicle owner; for unlocking, the mobile phone must be held centrally against the door handle of the driver's door.
- ▶ Connect key card: Key fob in the form of a credit card. To unlock, the key fob must be held centrally against the door handle of the driver's door.

Vehicle fire

In the case of vehicle fire, a distinction must be made between:



Vehicle fire without high-voltage battery fire:

Identical to a normal passenger car, all common and known extinguishing agents such as water, foam, CO₂ or powder can be used in the “normal” case of fire of a hybrid or battery electric vehicle (HEV or BEV, where the high-voltage battery does not burn), depending on requirements and/or availability.

Avoid water ingress into the high-voltage battery!



Vehicle fire with high-voltage battery fire:

In the case of a burning high-voltage battery, it should be extinguished with a water spray if possible and then cooled. Make sure that plenty of water is used. As possible the water should ingress into the high-voltage battery.



Take care to use appropriate personal protective equipment (e. g. compressed air breathing apparatus, fire-fighting garments, thermal imaging camera, etc.).

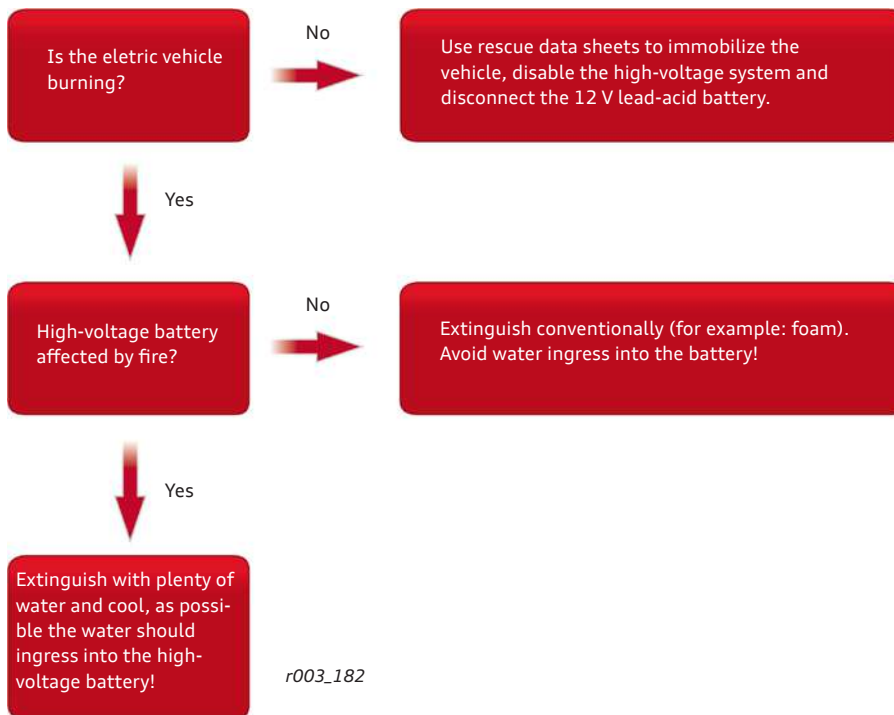

Salvage from water

A hybrid vehicle (HEV) or battery electric vehicle (BEV) submerged in water usually doesn't pose a danger of an electrical hazard (electric shock).

After recovering the vehicle from the water, the rescue services should drain the water out of the interior. Subsequently, works on the vehicle can be performed taking into account the mentioned notes for the rescue work.



Water entering the lithium-ion battery may cause reactions. In this case, observe the general safety information of the lithium-ion battery.

General Safety Information about Lithium-Ion Batteries

A lithium-ion battery can react either immediately or with a delay due to severe damage (e. g. crushed, broken or cracked housing) or exposure to water or fire. Therefore, watch out for any signs (e. g. smoke, heating, noise, sparks, etc.) while working on a vehicle with a lithium-ion battery which has been damaged in an accident.

If the lithium-ion battery reacts, protective measures and countermeasures must be taken (see “Vehicle fire” on page 40). After a reaction, the lithium-ion battery must be cooled with water until it has reached approximately ambient temperature. The use of a thermal imaging camera or an IR thermometer is recommended.

Before transporting the vehicle (e.g. by a towing company), the condition of the lithium-ion battery must be re-checked. The vehicle may only be loaded and transported if the reaction has ended to such an extent that it can be assumed that no further reaction is to be expected on the transport route.

The shortest and safest route must be chosen. Passages through tunnels should be avoided.

In some cases it may be appropriate for the towing vehicle to be accompanied by a fire-fighting vehicle.

The vehicle involved in the accident must be parked in a suitable place outside because the lithium-ion battery still has the theoretical potential to react. The parking space must be marked accordingly (signage/delimitation). A distance of at least five meters from other vehicles, buildings or combustible objects must be maintained.

The responsible persons of the towing company, the workshops and, if applicable, the disposal companies must be informed of the special features and risks of the vehicle!

Lithium-ion battery disconnected from the vehicle

If the high-voltage energy storage system and/or parts of it are disconnected from the vehicle in the event of an accident, the high-voltage energy storage system poses an electrical, chemical, mechanical and thermal hazard. In such a case, the following aspects must be considered:

If high-voltage energy storage systems, high-voltage components or high-voltage cables are damaged (e. g. open components or torn cables), contact with these damaged parts must be avoided!

During unavoidable work in these areas, damaged components or high-voltage energy storage systems must be covered by electrical insulation.

In this respect, it is recommended to use an appropriate electrically insulating pliant cover (undamaged plastic foil or other appropriate electrically insulating cover, e. g. according to IEC 61112).

Even when the high-voltage energy storage system has been disconnected from the vehicle, parts of the entire energy storage system can remain in or on the vehicle.

Separated components of high-voltage energy storage systems must only be picked up from the ground with electrically insulating equipment!

Leaking electrolytes from damaged high-voltage energy storage systems are usually irritant, flammable and potentially caustic. Leaking liquids from high-voltage energy storage systems are usually coolants. There are only small amounts (millilitres) of electrolytes in the individual cells.

Dry leather gloves as well as dry operational gear provide basic protection against electric voltage. Nitrile under-glove offer additional safeguard against electric voltage and chemicals. For facial protection, the helmet visor should be lowered at all times when working.

For the transportation of a high-voltage energy storage system disconnected from the vehicle or components of it, a large metal container is recommended.

The condition of the high-voltage energy storage system must be observed (e. g. smoke, noise, sparks, heating) and the flooding of the metal container must be prepared.

Natural gas drive (g-tron)

g-tron

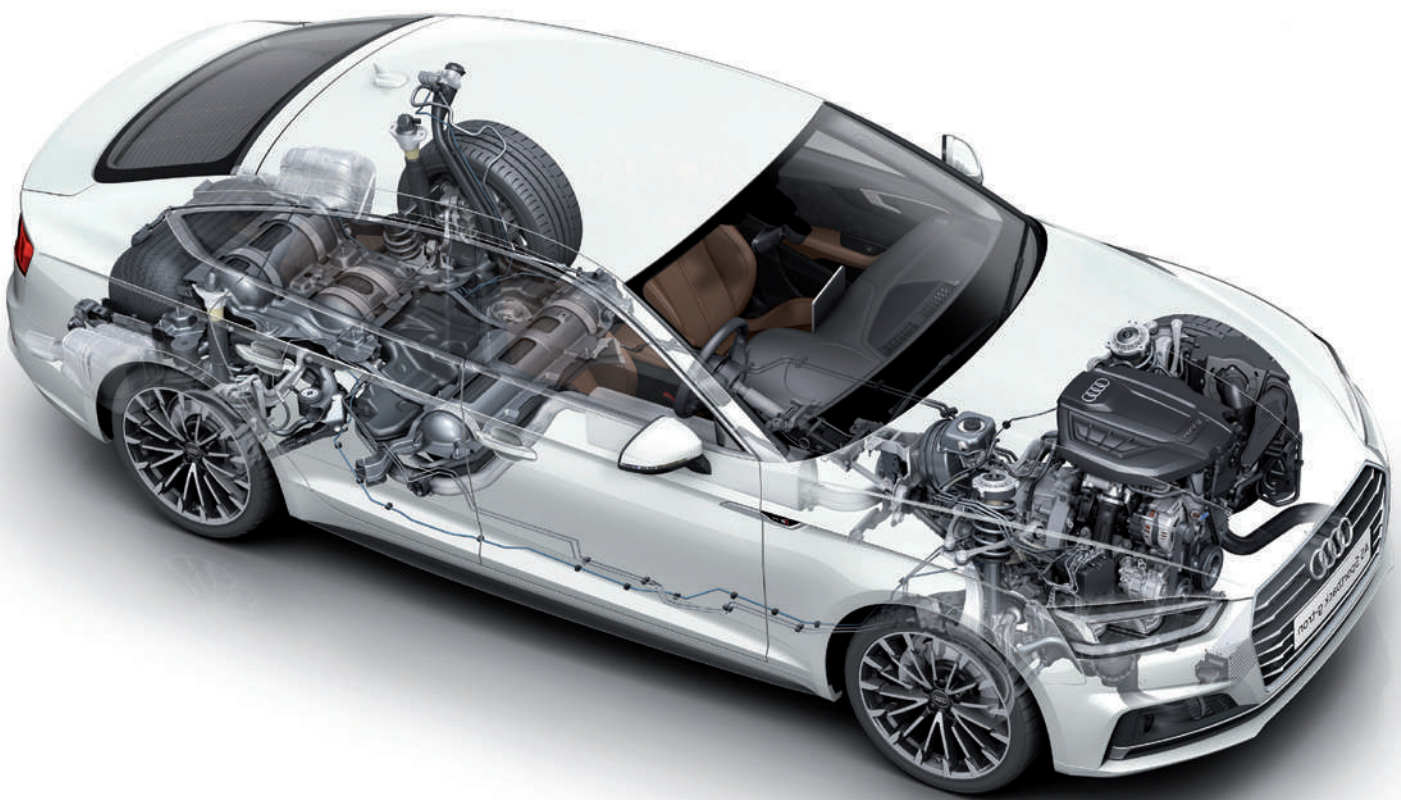

Vehicle identification – Natural gas vehicles

In most cases, the exterior of natural gas vehicles does not differ from conventionally driven models. A type designation at the vehicle rear or at the mudguard may be an indication of a natural gas vehicle. Audi uses the lettering “g-tron” for natural gas vehicles.

If the vehicle does not have a type designation, other characteristics may also point to a vehicle with natural gas system. For the Audi “g-tron”, for example, these are:

- ▶ Natural gas tank nozzle
- ▶ Fuel indicator in the instrument cluster
- ▶ Identification or lettering in the instrument cluster

The non-existence of these signs however is not a clear indication that the vehicle does not have a natural gas system.



Sometimes the lettering can be deselected during vehicle configuration; it is also possible that the vehicle owners remove them.

Distinguishing characteristics – natural gas vehicles



r001_029

Type designation “g-tron” at the vehicle rear



r001_028

Natural gas tank nozzle

Open fuel filler flap with additional natural gas tank nozzle



r001_070

Fuel indicator and lettering in the instrument cluster



r001_049

Lettering on the design cover in the engine compartment

Technical fundamentals

Introduction

The combustion engine of Audi natural gas vehicles can be operated with natural gas or with petrol. The primary drive uses natural gas, the petrol tank is a reserve.

Handling natural gas vehicles is generally not more dangerous than handling petrol or diesel vehicles; however, it differs in some items. Knowledge about these differences can be important for the rescue work after car accidents.



Natural gas (CNG – Compressed Natural Gas) must not be confused with liquid gas (LPG – Liquefied Petroleum Gas). Liquid gas and liquid gas installations differ fundamentally from natural gas and natural gas installations

Audi A5 Sportback g-tron as example of a natural gas vehicle

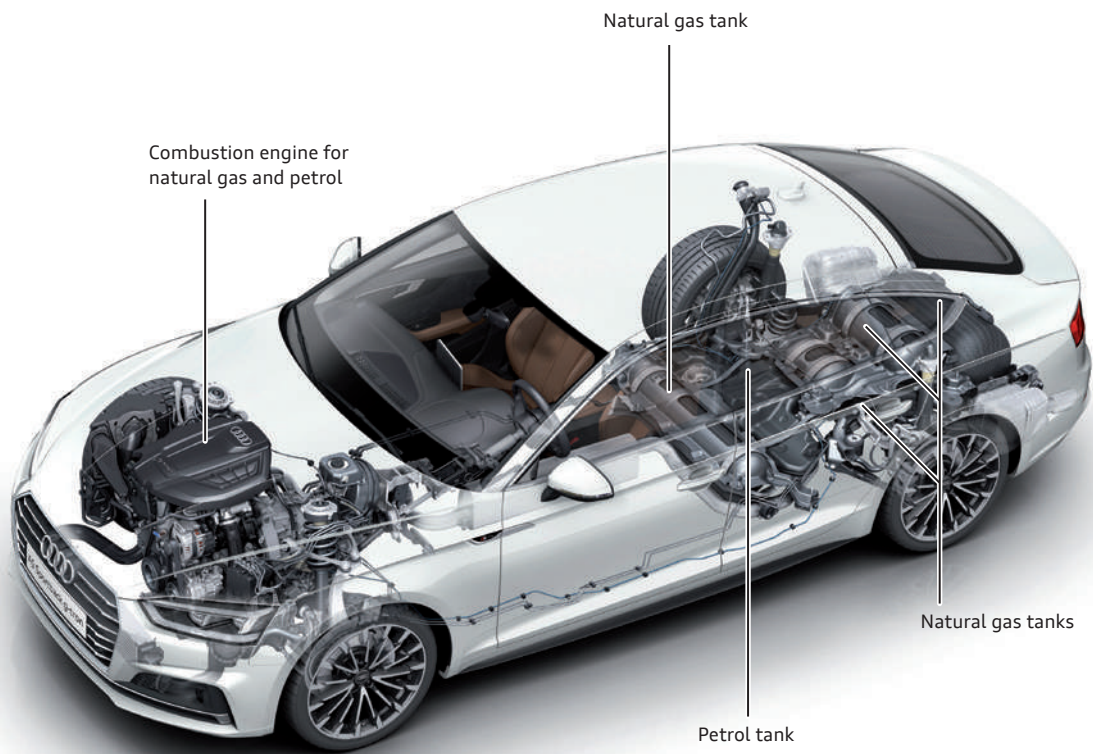

r003_166

Natural gas as a medium

Physical properties of natural gas

- ▶ Natural gas is a colourless, flammable gas (fire class C) which is odourless in original condition.
- ▶ For the use in vehicle it is odorized, i. e. an odorant is added to the gas. Thus, a natural gas leak can be detected already before the lower explosion limit is reached.
- ▶ Natural gas is lighter than air (density ratio natural gas/air approx. 0.6) and is thus very volatile in the open!
- ▶ Explosion range between 4 volume % and 17 volume %
- ▶ Ignition temperature approx. 640 °C

Audi A3 Sportback g-tron – Overview of natural gas components

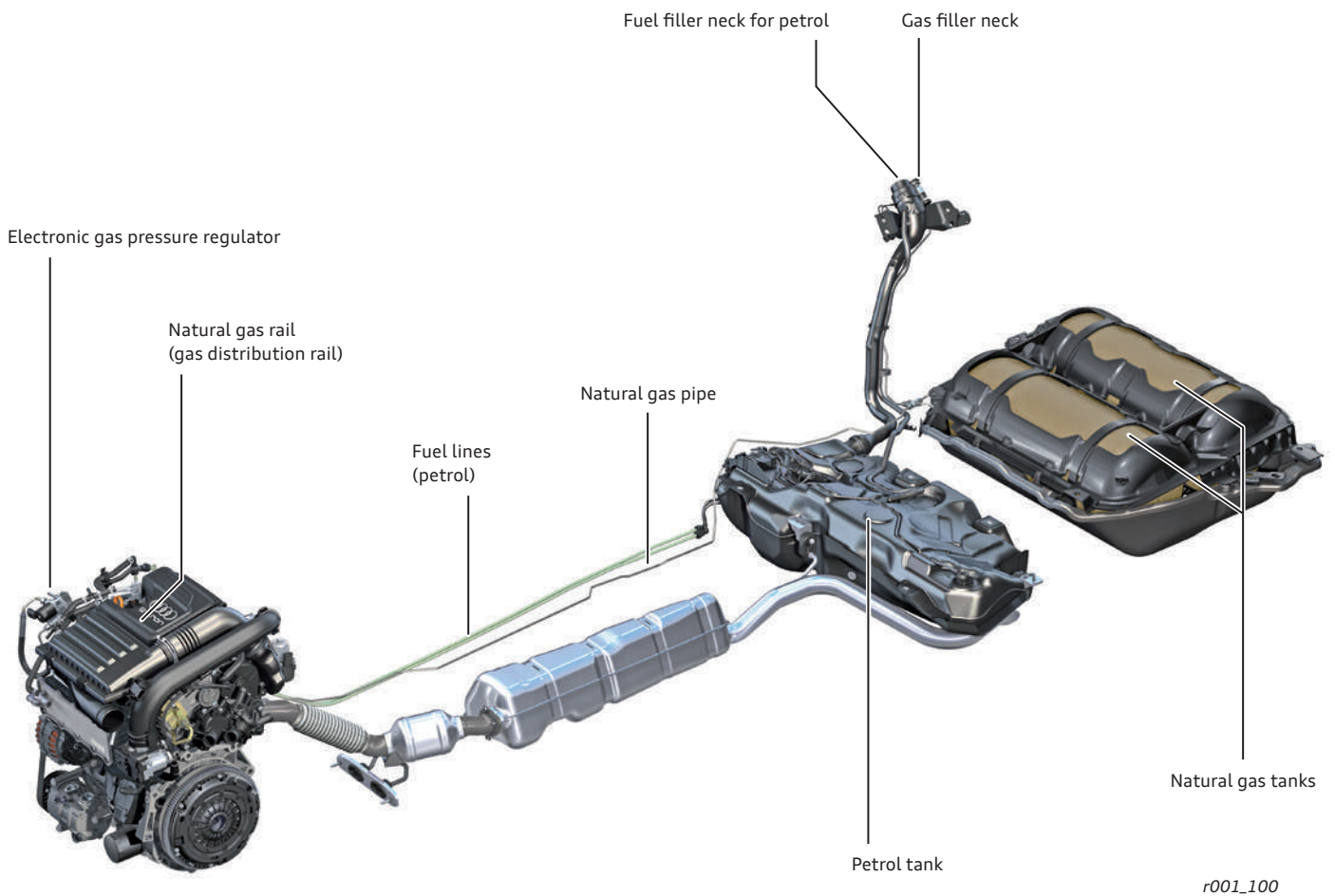

Natural gas technology – “g-tron”

Schematic view of the natural gas system

A natural gas system consists of a high pressure part and a low pressure part. In the high-pressure range, the system pressure at 15 °C can be up to 200 bar. The low pressure range can be up to 12 bar.

The gas filler neck and the natural gas tanks with the tank shutter valves are located in the vehicle rear. The gas tubes are installed on the underside of the vehicle and flow toward the electronic gas pressure regulator in the engine compartment.

From the electronic gas pressure regulator the natural gas is transferred to the natural gas rail from where it is blown into the engine via injector valves.

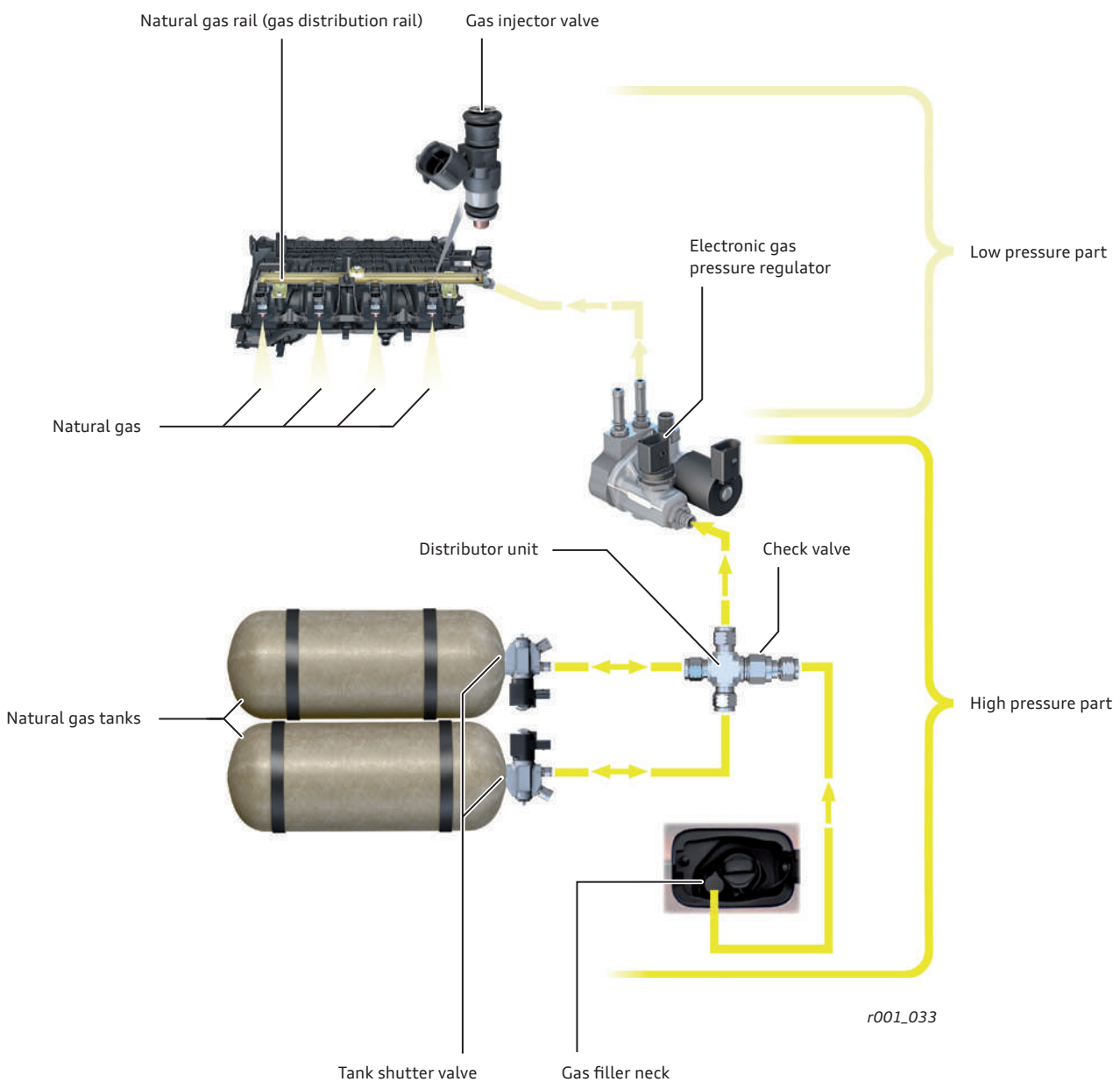

Natural gas tanks

The natural gas tanks on the Audi g-tron models are installed in the rear on the underside of the vehicle. The new Audi models A3 g-tron, A4 g-tron and A5 g-tron have an additional natural gas tank in the rear axle and fuel tank areas. The A4 g-tron and A5 g-tron models have a fourth natural gas tank located in the rear above the subframe of the rear axle. They are fixed with tensioning straps to a carrier screwed to the car body.

During filling and emptying, but also due to temperature variations, the diameter of the natural gas tanks can change by a maximum of 2 mm. A protective layer is positioned between carrier, tensioning straps and natural gas tanks in order to avoid damage caused by expansion and contraction.

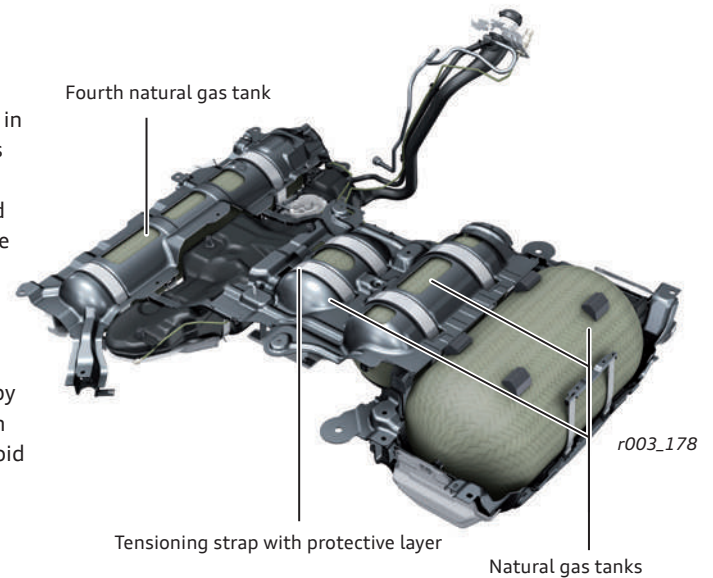

Structure

The natural gas tanks are made of layered combined plastics.

Layer structure:

- ▶ Interior – layer of gas-tight polyamide
- ▶ Intermediate – layer of carbon fibre reinforced plastics (CFRP)
- ▶ Exterior layer – glass fibre reinforced plastics (GRP)
(the GRP layer serves in particular for robustness and protection against damage) It also serves to make damages visible. The fibreglass-reinforced plastic suffers a so-called stress whitening (whitish discoloured fracturing) under unacceptably high loads.

The binding agent for the used fibre materials is high-strength epoxy resin.

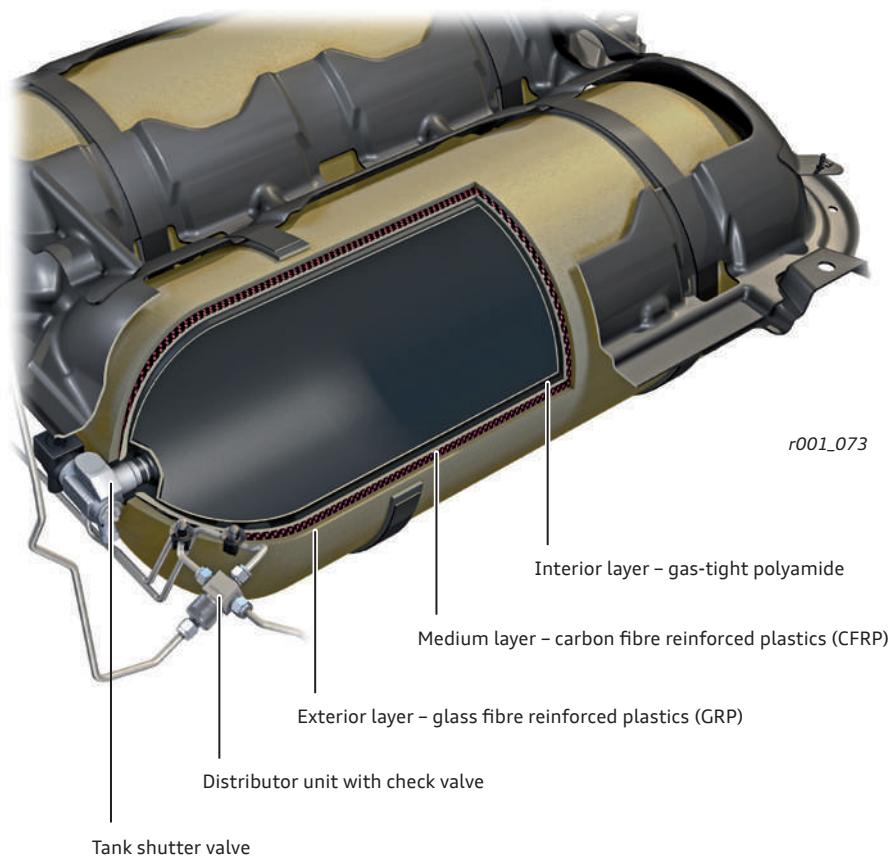

Safety installations

The natural gas installation is built in a way that it is protected against damage. The gas tanks are stable and heat-resistant.

The high pressure lines are installed outside the passenger compartment. The natural gas components are equipped with different safety devices. Natural gas vehicles generally have the same degree of safety as conventionally powered vehicles.

Cylinder valve

Apart from the valves for tank shutting, the cylinder valves have an integrated thermal fuse, a flow rate limiter as well as a manual shut-off valve.

If it is necessary to shut off the gas tanks for rescue work, each gas tank must be shut off separately.

The manual shut-off valve can be shut with an open-end wrench or a ring wrench No. 5, at the square, by turning clockwise until reaching the stop.

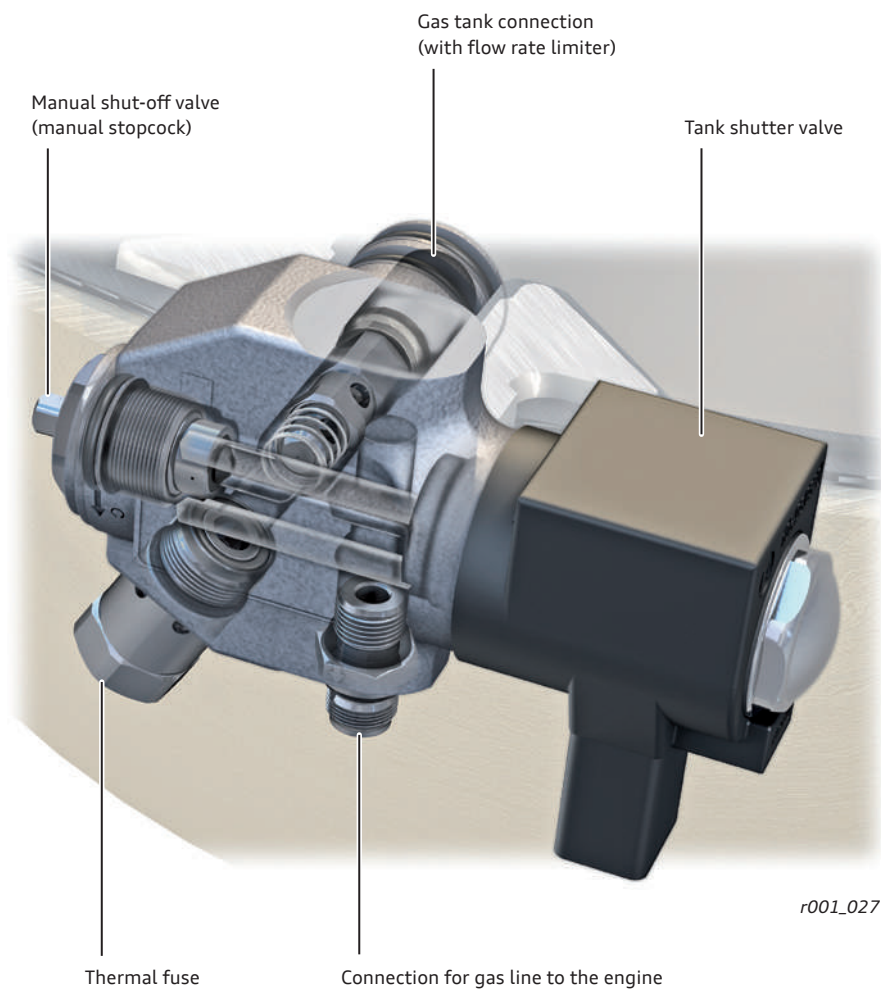

Tank shutter valve

The tank shutter valve is an electromagnetic valve which is opened during natural gas operation by the engine control unit. The valve closes automatically when the motor is shut off, during petrol operation, in case of a loss of voltage supply, as well as in a crash with activation of the airbag or belt pretensioner.

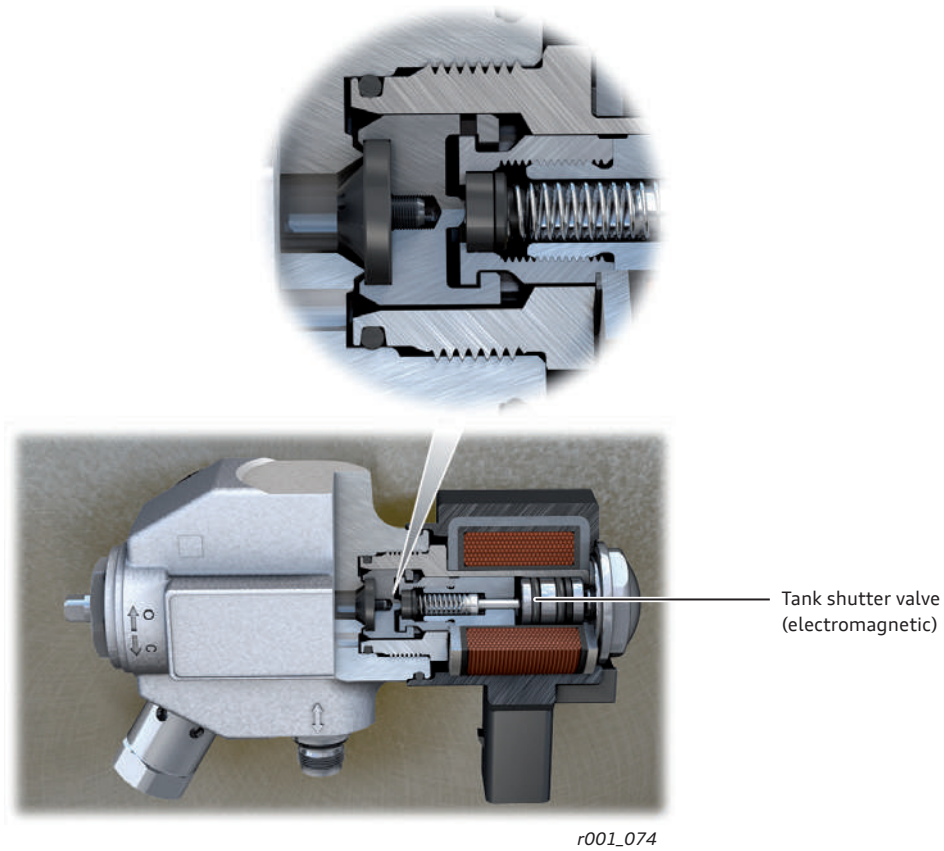

Flow rate limiter

In case of a possible damage of lines or of the gas pressure regulator, the flow rate limiter reduces an uncontrolled outflow of gas. The flow rate limiter reduces leakage to a maximum of 0.05 Nm³/min at 100 bar, i. e. a small residual leakage remains. The fuel outflow can be completely stopped at cylinder valves with manual shut-off valve (manual stopcock) by closing the manual shut-off valve.

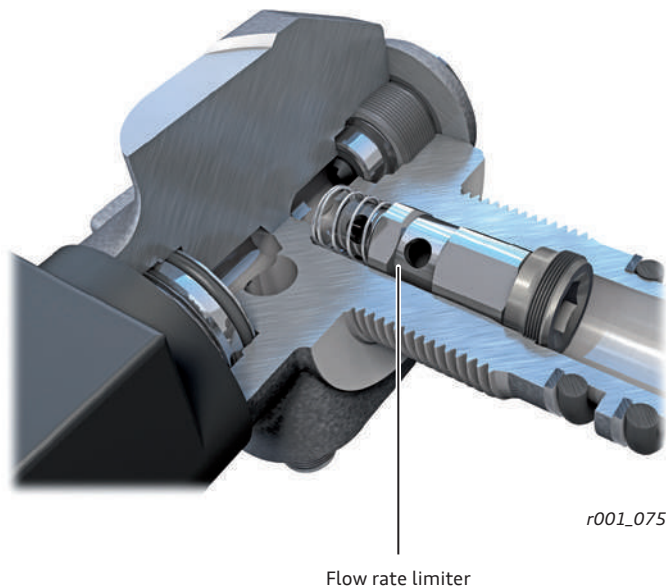

Thermal fuse

The thermal fuse prevents the natural gas tank from exploding due to excessive pressures at high temperatures.

In case of normal temperatures the thermal fuse closes the opening to the outside air.

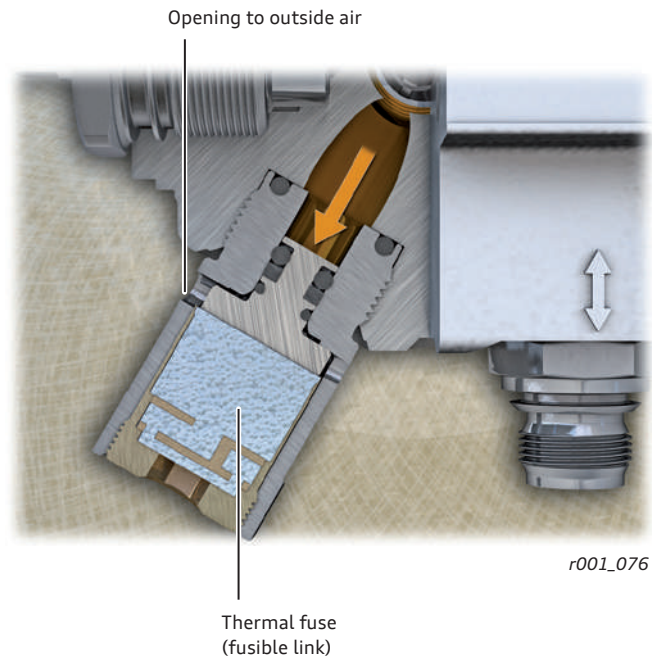

If the thermal fuse is heated for a determined period of time to a temperature of more than 110 °C, the fusible link melts and the opening to outside air is released.

Now the natural gas releases from the gas tank in a restricted way into the atmosphere (blow-off), ignites if a source of ignition is present, and then burns off. The release cannot be interrupted due to system, i. e. the tank will be almost completely emptied in any case.

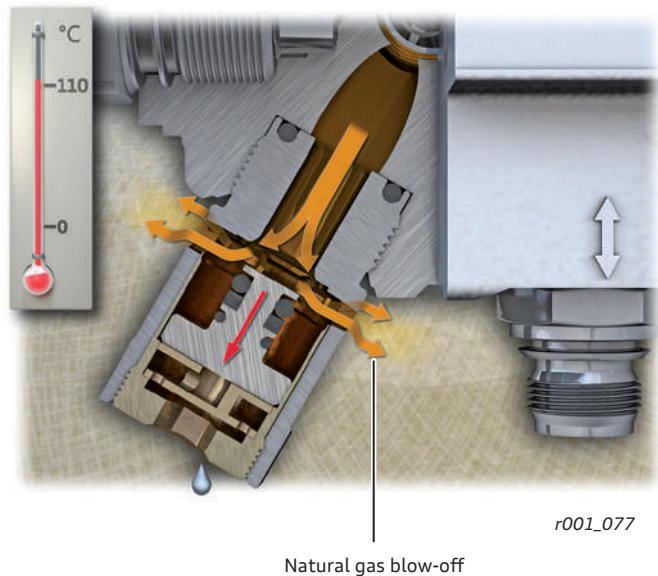

Manual shut-off valve (manual stopcock)

The natural gas tank can be closed manually with commercially available tools at the manual shut-off valve – see also information text “Cylinder valve” (on page 49).

For safety reasons, the connection to the blow-off channel of the thermal fuse is open even if the manual shut-off valve is closed.

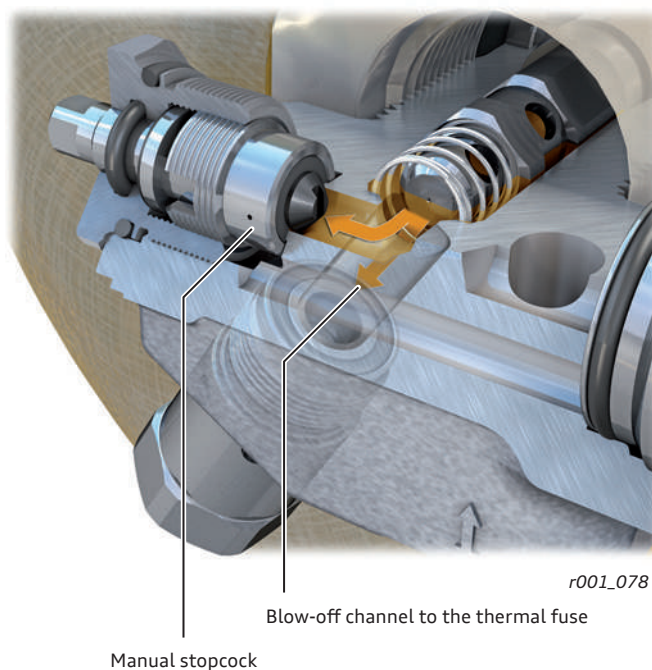

Notes for the rescue work

Handling natural gas vehicles is generally not more dangerous than handling petrol or diesel vehicles; however, it differs in some items. Knowledge about these differences can be important for the rescue work after car accidents.

Technical assistance

The safety concept, in particular the type of installation of the natural gas tanks and associated components, and for example the regulation of the gas pressure for avoiding unacceptable overpressure in the gas system, generally ensures that no special or additional danger is posed by the natural gas system.

The procedures of rescue services are generally regulated by corresponding laws, regulations or guidelines. In addition, further information is provided by the relevant specialist bodies or associations (see e. g. DGUV Information 205-022: Rescue and fire extinguishing work on passenger cars with alternative drive technology).

The subsequent chapters generally highlight issues which could become significant during the technical assistance after accidents of involving vehicles with natural gas drive.

Rescue data sheets

Vehicle specific peculiarities are described in the rescue data sheets.



The rescue data sheets for vehicles with natural gas drive may contain additional information about the handling of the vehicle. In particular, the procedure for the deactivation of the vehicle can be taken from the rescue data sheets of these vehicles in most cases.

Apart from the indications normally included in the rescue data sheets of conventionally driven vehicles, the rescue data sheets for natural gas vehicles indicate the position of the natural gas pressure tanks and the tank safety valves.

In addition to schematic top and lateral view (on the first page) rescue data sheets may include further pages with the following sections:

- ▶ Access to the natural gas tanks
- ▶ Localization of manual stopcocks
- ▶ Manual closing of gas tank

The symbols in the rescue data sheets which apply in particular to natural gas vehicles are:

Symbol	Designation	Symbol	Designation
	Natural gas pressure tank		Tank safety valve



The example on the following page shows the overall structure of a rescue data sheet.

Example for a rescue data sheet

Rescue data sheets for the Audi A5 Sportback g-tron (status 07/19)

Sheet 1

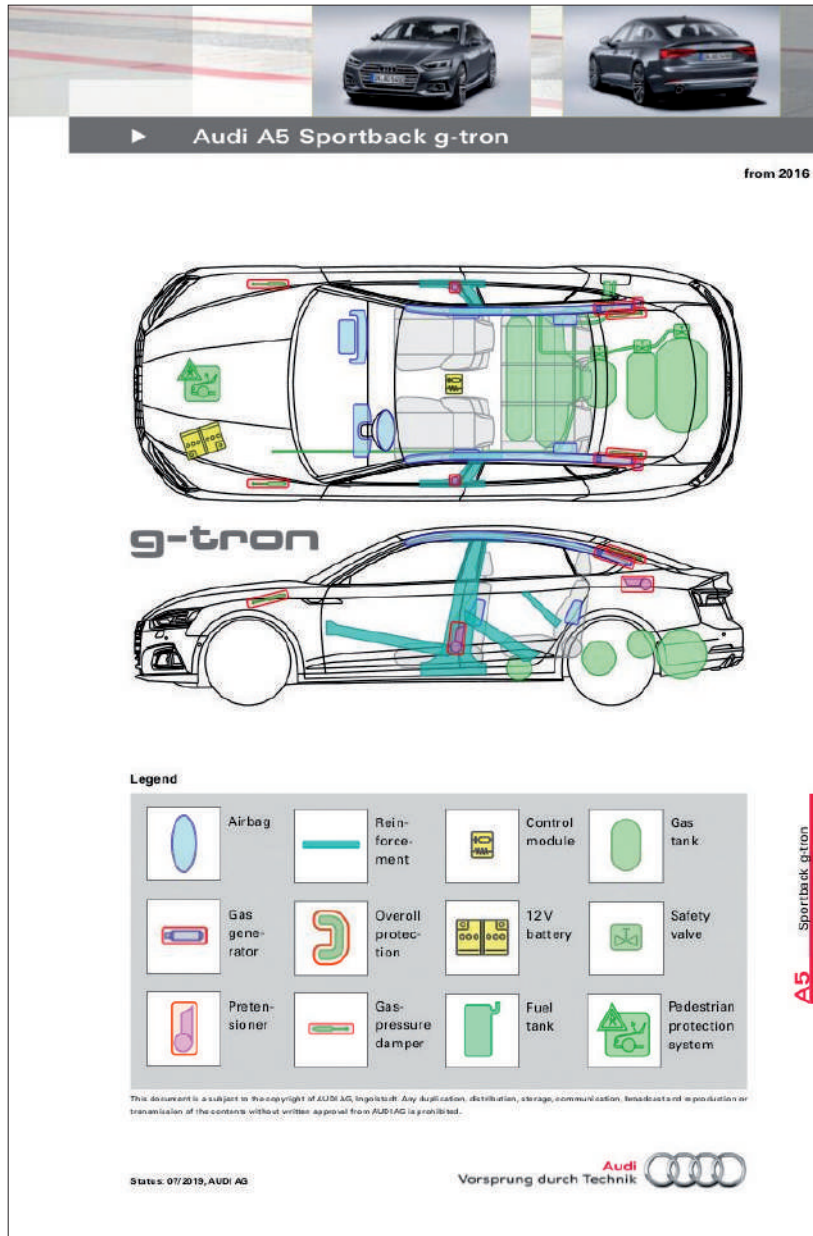

r003_185

The rescue data sheets for Audi vehicles can be downloaded on the Audi website under:
<http://www.audi.de/rettungleitfaden>

The website of the German Association of the Automotive Industry e. V. (VDA) provides an overview of the sources of supply for rescue data sheets of all automobile manufacturers:
<https://www.vda.de/en/topics/safety-and-standards/rescue/rescue-data-sheets.html>

Vehicle accident or gas outflow in case of a natural gas vehicle

General approach

The following measures should be taken generally after an accident (the same as for all vehicles of the Audi AG)

- ▶ Switch off the ignition
- ▶ Disconnect the battery/batteries
- ▶ Disconnect the trailer power supply



In case of a critical gas concentration (>20 % LEL), do not disconnect the battery.

Procedure in case of leaking natural gas

If leaking natural gas is detected at the place of the accident (e.g. due to the smell of gas), the following measures should be taken:

- ▶ Switch off the engine
- ▶ Switch off the ignition
- ▶ Clear and cordon off the danger zone
- ▶ Do not start the vehicle; if necessary, remove from closed premises by pushing
- ▶ Ventilate the vehicle interior (open doors, windows, engine hood and luggage compartment)
- ▶ Determine gas concentration, observe accumulations in cavities, allow cross ventilation if necessary; disperse natural gas with fan; avoid sources of ignition.

Vehicle fire

In case of a burning vehicle, when also the natural gas tanks heat up considerably, the thermal fuses activate at approximately 110 °C, and a defined blow-off, ignition and burning of the natural gas occurs.

The blow-off of a full natural gas tanks lasts approximately 90 seconds until complete emptying.

Vehicles can be equipped with one or more gas tanks. The point in time when and which tank blows off or flares, cannot be determined exactly.

If no other dangers are present as e. g. spreading of the fire to other objects etc., the controlled burning of the vehicle must be taken into account if natural gas blows off and flares.

As soon as the blow-off of natural gas has ended, conventional fire-fighting can be started.

If the natural gas tanks are not affected by the fire (e. g. in case of a fire in the engine compartment), conventional fire-fighting can be started immediately.



If the vehicle lies on the side or on the roof, shooting flames must be expected when the overpressure protection trips. There are several blow-out openings along the thermal perimeter; the gas exits from these openings in all directions. A safety distance must be kept to the vehicle. The vehicle must be approached from the front with an angle, if possible.



If possible, the gas tank must be cooled with water, from a safe place, in order to avoid heating to a temperature where the overpressure protection trips. Tank cooling must be continued even if the overpressure protection trips.



The tripping of an overpressure protection can be recognized by a loud blow-off noise (hissing)!

