

Information for first and second responders
Emergency response guide for vehicle



Polestar 2
100% electric vehicle

400V
Lithium-ion
Battery





Polestar 2
Type: 5dr hatchback
(2020 -)

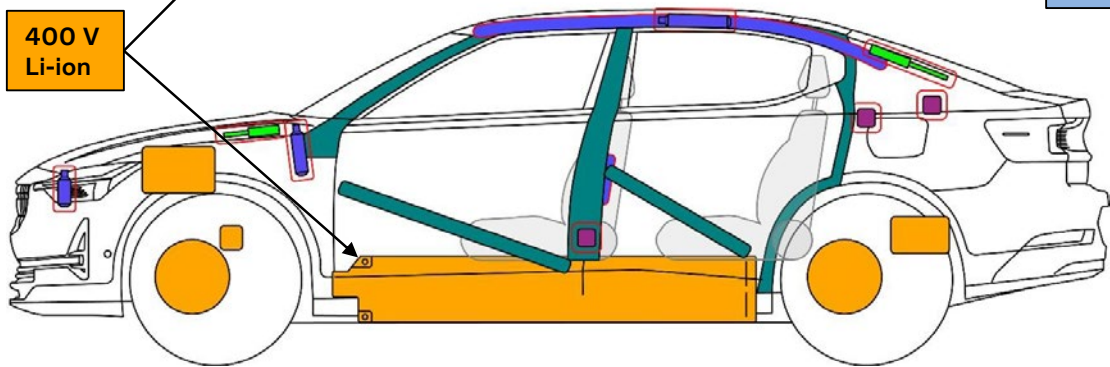
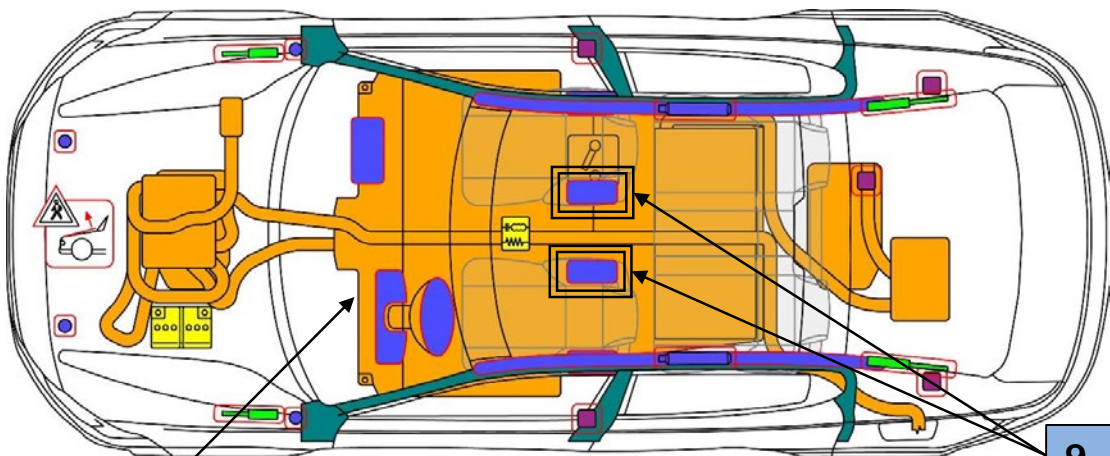

- | | | | | | | | | | |
|--|--------------------------------------|--|--|--|---|--|----------------------------------|--|-------------------------------------|
| | Airbag | | Stored gas inflator | | Seat belt pretensioner | | SRS controlunit | | Pedestrian protection active system |
| | Automatic rollover protection system | | Gas strut/Preloaded spring | | High strength zone | | Zone requiring special attention | | |
| | Battery low voltage | | Ultra-capacitor, low voltage | | Fuel tank | | Gas tank | | Safety valve |
| | Battery pack, high-voltage | | High voltage power cable / - component | | High voltage device that disconnects high voltage | | Fuse box disabling high voltage | | High voltage ultra-capacitor |

Document N°	Version N°	Version date	Page N°
RDS_Polestar_2-ENG	01	05/2021	1 / 4

Polestar 2: 5dr hatchback (2020 -) – Additional Pages

1. Identification / recognition



LACK OF ENGINE NOISE DOES NOT MEAN VEHICLE IS OFF. SILENT MOVEMENT OR INSTANT RESTART CAPABILITY EXISTS UNTIL VEHICLE IS FULLY SHUT DOWN. WEAR APPROPRIATE PPE.

Brand name front



Brand name rear



Charge port



2. Immobilization / stabilization / lifting

Immobilize vehicle:

1. Block wheels and set parking brake;
2. Push the P (park) button to select the P (park) position.

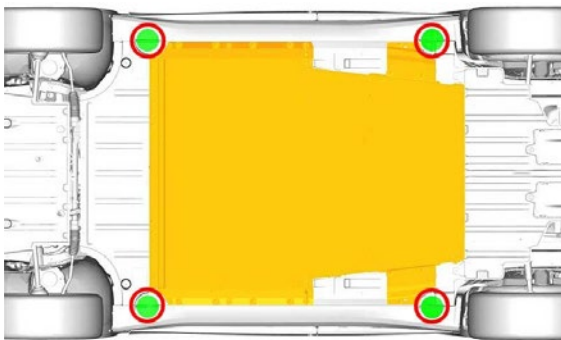

Lifting points:

- Appropriate lifting points;
- High voltage battery;

3. Disable direct hazards / safety regulations

The propulsion system is disabled when the 'Safety mode See Manual' indicator in the instrument cluster is illuminated.

Deactivation of propulsion system, if 'Safety mode See Manual' indicator is not illuminated:

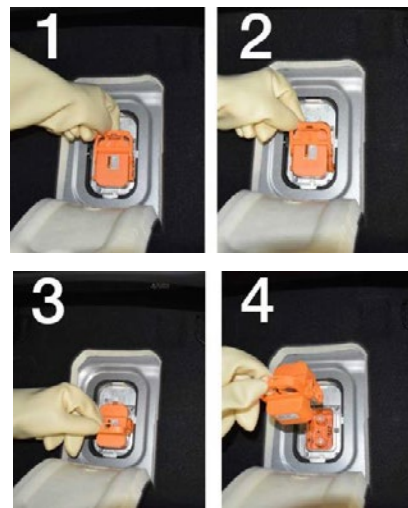

Document N°

RDS_Polestar_2-ENG

Version N°

01

Version date

05/2021

Page N°

2 / 4

Polestar 2: 5dr hatchback (2020 -) – Additional Pages

Disconnect 12 Volt battery

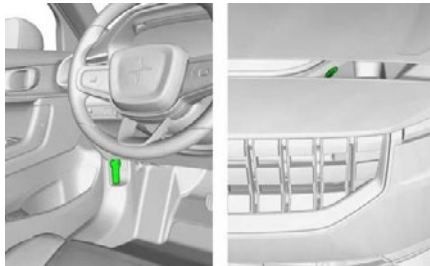
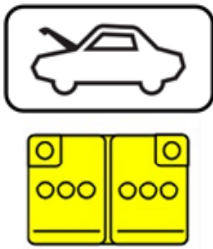

Safety regulations:



Always assume the vehicle is powered, even if it is silent!
 Make sure that the vehicle is immobilized and the propulsion system is deactivated;
 Never touch, cut, or open any orange high voltage power cable or high voltage component;
 In case of a collision with airbag deployment and/or seat belt pretensioner activation, the propulsion system will be disabled. The restraint systems are still active.

4. Access to the occupants

Seat adjustment

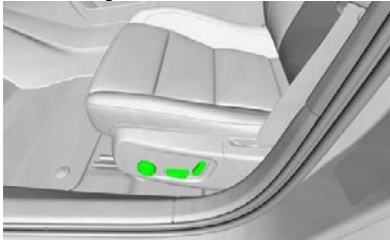

Steering column adjustment



Glass types:

- A. Laminated glass.
- B. Tempered glass.



5. Stored energy / liquids / gases / solids

	400V	
	12V	
	R-1234yf 395-445 g	



When conventional coolant leaks (check reservoir ?) from the high voltage (HV) battery cooling system, HV-battery can become unstable with risk of thermal runaway. An increasing HV-battery temperature might be an indicator of thermal runaway.



6. In case of fire

Extinguish method for the high voltage (HV) battery:



USE LARGE AMOUNTS OF PURE WATER DIRECTLY TO THE HV-BATTERY



POTENTIAL RISK OF BATTERY RE-IGNITION / DELAYED IGNITION!

	Document N°	Version N°	Version date	Page N°
	RDS_Polestar_2-ENG	01	05/2021	3 / 4

Polestar 2: 5dr hatchback (2020 -) – Additional Pages

7. In case of submersion

- There is no increased risk of electric shock in water resulting from the high voltage system;
- If possible, remove the vehicle from the water and continue with the deactivation procedure for this vehicle (see chapter 3).

8. Towing / transportation / storage

Recovery hook storage



Location front hook



Location rear hook



STORE VEHICLE IN AN OPEN-AIR PARKING AT SAFE DISTANCE \geq 5M FROM OTHER OBJECTS OR VEHICLES!



POTENTIAL RISK OF BATTERY RE-IGNITION / DELAYED IGNITION!

Towing



9. Important additional information

Centre airbag



10. Explanation of pictograms used

	Smart key distance		Electric vehicle
	Warning high voltage		Risk of flammability
	Caution		Risk of damaging human health
	Warning low temperature		Risk of acute toxicity
	Air-conditioning component		Risk of corrosive material / substances
	Use water to extinguish the fire		Bonnet
	Use IR Camera (thermal imaging)		

Document N°

RDS_Polestar_2-ENG

Version N°

01

Version date

05/2021

Page N°

4 / 4

Introduction Electrical Vehicle Emergency Response Guide

This publication is intended for rescue personnel especially trained for rescue operations at vehicle accidents. The folder shows Polestar 2 equipped with all optional and accessory equipment.

For information about the vehicle's features, embedded systems and safety systems we refer to the owner's manual available digitally in the center display of the vehicle.

This guide is intended to be used by trained first responders and rescuers and assumes that the reader has professional level skills in safely responding to emergencies and rescue situations described in this guide, including those involving damaged vehicles. This guide is not intended for retailers, end consumers or any other reader that is not described in the preceding sentence. This guide may be updated by Polestar at any time. This guide applies to the Polestar 2 only and includes information about the specific vehicle's structure and components, including location and description of high voltage components. While failure to follow this guide may result in serious injury or death, each emergency situation is unique and this guide may not address every scenario and even if this guide is followed, serious injury or death may occur.

Copyright © 2021 Polestar

Special texts

 WARNING
Warning texts appear if there is risk of injury.

 IMPORTANT
Important texts appear if there is risk of damage.

 NOTE
Note texts give advice or tips that facilitate the use of e.g. features and functions.

Option/accessory

We continuously work to develop and improve our products. Modifications can mean that information, descriptions and illustrations in this publication differ from the equipment in the vehicle. We reserve the right to make changes without prior notice.

Vehicles may be equipped differently depending on market requirements and national or local laws and regulations. In addition to standard equipment, the vehicle can also have been modified with optional equipment (factory-installed equipment) and certain accessories (extra retrofitted equipment).

All, at the time of publication known, options and accessories are marked with an asterisk: *.

Contents

01. Identification / Recognition	6
1.1 Electric vehicle recognition	6
1.2 Basic parameters of the vehicle	9
1.3 High voltage components	10
02. Immobilisation / Stabilisation / Lifting	12
2.1 Vehicle stopping operations	12
2.2 Lifting	14
03. Disable direct hazards / Safety regulation	15
3.1 Disconnection of high voltage	15
3.2 Ending the charging of the traction battery	17
04. Access to the occupants	19
4.1 Access to the occupants	19
4.2 Body framework	20
4.3 No-cut zones	22
4.4 Adjusting the seats and steering wheel	23
4.5 Airbags and seat belt pretensioners	24

Contents

05. Stored energy / Liquids / Gases / Solids	25
5.1 Component overview	25
5.2 First Aid Measures	27
06. In case of fire	28
6.1 Emergency rescue in case of fire	28
07. In case of submersion	30
7.1 Emergency rescue in the case of submersion	30
08. Towing / transportation / storage	31
8.1 Hauling of the vehicle from the scene after an accident	31
09. Important additional information	34
10. Explanation of pictograms used	35

Electric vehicle recognition

The Polestar 2 can be identified as an electric vehicle in a number of places.

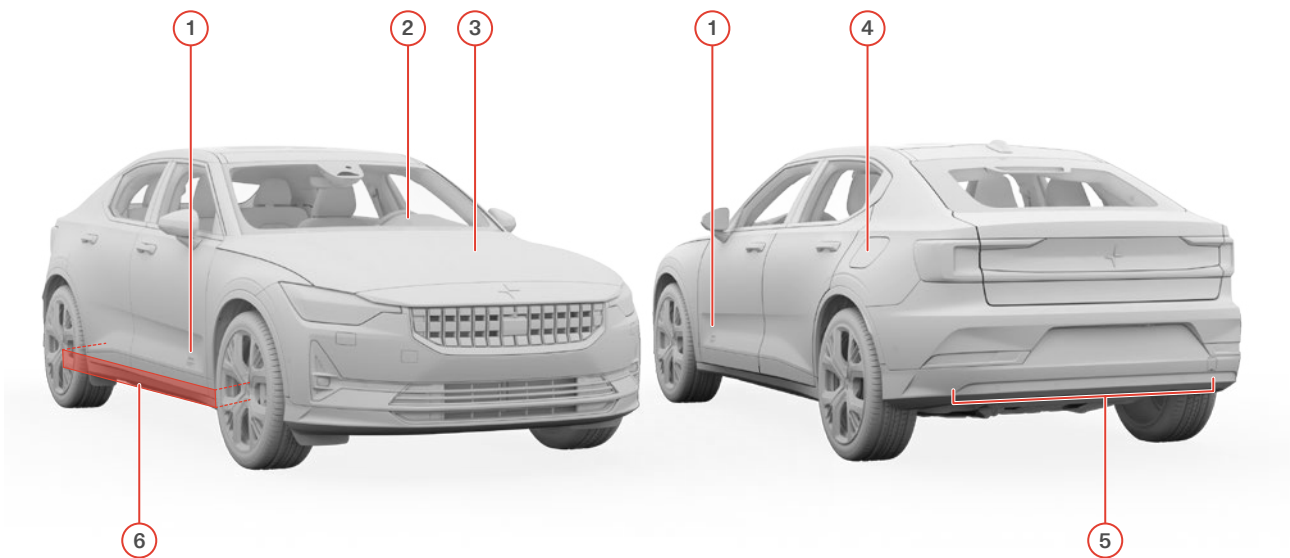

① Lettering/badges

② Driver display

③ Frunk

④ Charging lid

⑤ No exhaust pipes

⑥ Traction battery

Charging lid



The charging lid is placed on the driver's/left side of vehicle.

Frunk



Due to absence of an Internal Combustion Engine (ICE), there is a front luggage compartment under the hood.

No exhaust pipes



There are no exhaust pipes for the Polestar 2.

Lettering/badges



Lettering ("Polestar 2 Battery Electric Vehicle") on the door on the driver's and passenger's side of the vehicle.

Driver display



Battery symbol in the driver display shows that the vehicle is a battery electric vehicle (BEV).

Traction battery

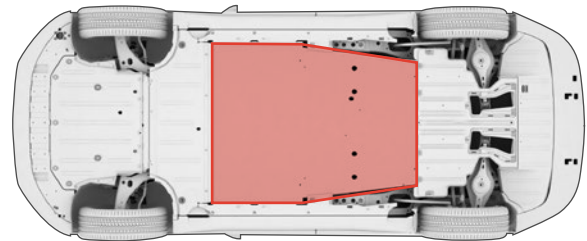

The traction battery is placed under the vehicle. The aluminum base of the battery system is visible from underneath the vehicle.

Basic parameters of the vehicle¹

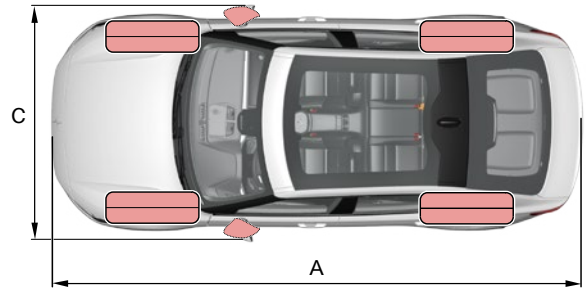
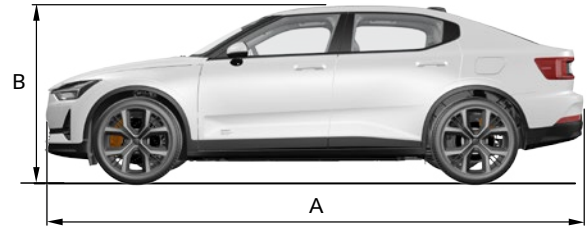

	Dimensions	mm	inches
A	Length	4606	181.3
B	Height ^A	1482 ^B 1477 ^C	58.3 ^B 58.1 ^C
C	Width	1985	78.1

A Including roof antenna, for kerb weight.

B Without performance package

C With performance package

Vehicle category	Sedan
Authorized passenger number:	5 seats. The rear seat is divided into two folding parts, with one or two passenger seats respectively.
Max. authorized total mass (kg):	2600

1. These numbers are the standard and may vary depending on the equipment of the vehicle. Look at the information decal for more information.

High voltage components

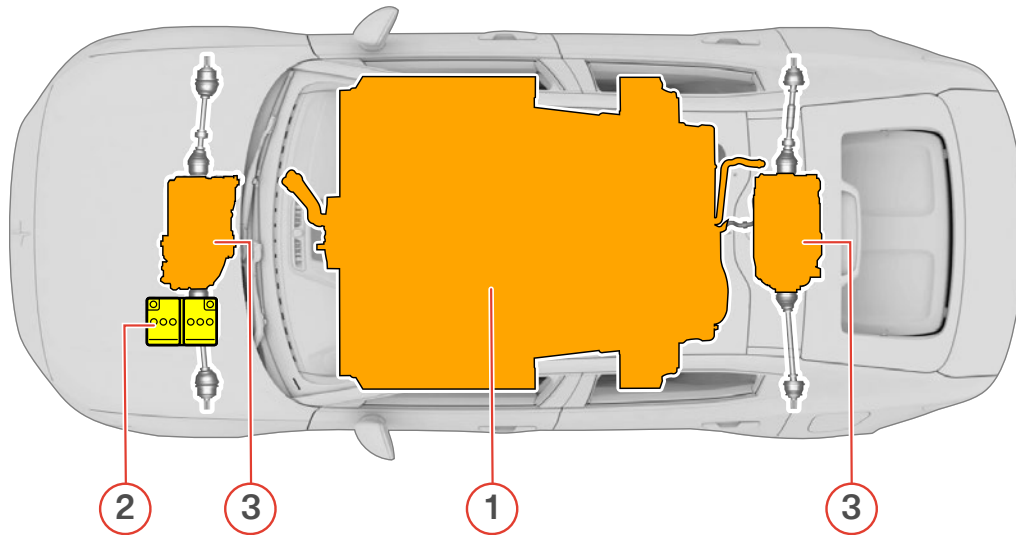

- ① Traction battery
- ② 12 V battery
- ③ Electric motors

Traction battery specifications

The traction battery consists of a number of modules in series which gives a nominal voltage of 397V depending of the battery's state of charge.

Cell type	Lithium-ion
Stored Energy	70-78 kWh
Weight	500 kg
Dimensions	1855x1464x353 mm (length x width x height)

Warning marking information



High voltage cables are colored in orange. Do not cut through high voltage cables.

Warning symbol for high voltage component.

An example of a label located on a high voltage component is shown below.



Vehicle Identification Number (VIN)

The VIN plate is located on the top left surface of the dashboard.

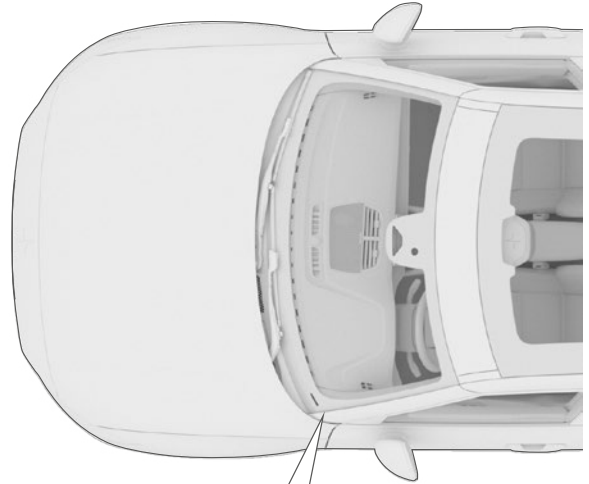

Vehicle stopping operations

For information of how to disconnect the traction battery, please see section 03 DISABLE DIRECT HAZARDS / SAFETY REGULATION.

Crash

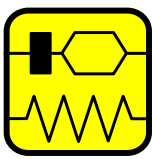

In the event of a collision, the Supplemental Restraint System (SRS) module sends a signal to the Central Electronic Module (CEM), stating that a collision has occurred. In this stage the vehicle assumes Crash mode. For safety reasons, the vehicle has limited functionality.

Among other things, the contactors in the traction battery are controlled to open and shut down the high voltage outside the traction battery. The passenger protection system like belt pretensioners and airbags are activated.

Automatic activation of the parking brake

The parking brake is activated automatically:

- if the car has entered Crash mode.
- if the driver unbuckles the seatbelt and/or
- opens the driver's door,
- when the vehicle is switched off manually in the center display,
- if the function Hold (brake when stationary) is activated and the vehicle has been stationary for a while (approx. 10 minutes).

Shifting the gear position to parking gear - P-mode

To shift the gear to P-mode, push the P-button located next to the gear selector on the armrest console. The vehicle must be at a standstill when selecting the parking gear.

NOTE

If the battery voltage is too low, the electrical parking brake can neither be released nor used.

When possible, always apply the parking brake when the vehicle is standing in a slope. Only putting the gear in P-position is not sufficient to stop the car. Turn off and stabilize vehicle

Automatic deactivation of the vehicle

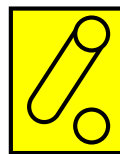

The vehicle is switched off automatically from drive mode if the vehicle has entered Crash mode or when the driver leaves the vehicle and it is parked.

1. Activate the parking brake.
2. Open the driver's door.
 - > The vehicle is now not in Drive mode.

Manual deactivation of the vehicle

It is possible to switch off the vehicle manually.

1. Activate the parking brake.
2. Tap .
3. Tap **More**.
4. Select **Power off vehicle**.
 - > The vehicle is now not in drive mode.

02. IMMOBILISATION / STABILISATION / LIFTING

NOTE

When the vehicle is turned off manually from the center display, the screens in the vehicle turns off. If the door opens the screens turns on again and the car is activated.

WARNING

Shutting off power to an electrical vehicle does not de-energize the traction battery, and a shock hazard may still be present.

Even though the vehicle is set to a state that is not the Drive mode, the vehicle can still be in an active state.

Stabilizing the vehicle with stop chocks

Stabilize the vehicle with stop chocks under the wheels. Stop chocks to be placed in front of or behind the wheels.



WARNING

Never stabilize the vehicle under the traction battery.

If the stop chocks are placed in contact with the battery it can be damaged which can be dangerous.

If the battery gets damaged it poses a threat which can result in personal injury or death.

Lifting

Remote control key range

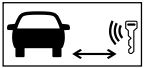

The vehicle is equipped with a key less system which activates the vehicle when entering the driving seat and closing the drivers door.

! IMPORTANT

Make sure that the key is removed from the vehicle to avoid unintentional activation. Keep the key in a safe distance from the vehicle.

The key works within a certain distance from the vehicle:

Usage	Range
Manual use (by pushing the buttons on the key)	Approx. 20 metres (65 feet) from the vehicle
Keyless use (with a remote control key or button less key)	A semicircular area with a radius of approx. 1.5 metres (5 feet) on both long sides and approx. 1 metre (3 feet) from the tailgate.



The traction battery is located under the vehicle. Use the lift areas shown in the image below. A large section of the undercarriage houses the traction battery. When lifting or stabilizing the vehicle, only use the designated lift areas, as shown in below.



WARNING

When lifting the vehicle, do not lift under the traction battery!

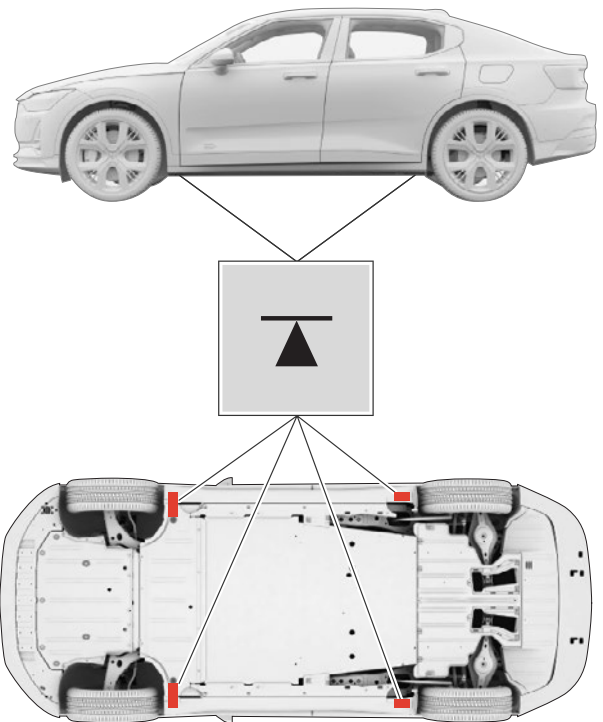

Disconnection of high voltage

Automatic disconnection

If a serious accident has occurred that has either triggered an airbag to deploy or the seatbelt pretensioner to activate, the traction battery pack is automatically disconnected from the rest of the high voltage system.

Make sure the traction battery is disconnected before starting any rescue procedures. Please see the section "[High voltage Manual service disconnect](#)" in this chapter.



WARNING

Residual voltage can remain in the system for approximately 10 seconds after the accident.

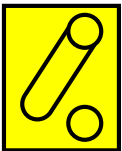

Secure that the vehicle is stabilized and turned off

1. When possible, always make sure that the vehicle is turned off and stabilized. See chapter [02. IMMOBILISATION/STABILISATION/LIFTING](#) for more information.

Disconnection of the 12 V battery



IMPORTANT

If the power front seats need to be adjusted, this must be done before the 12 V battery is disconnected, please see the section "[Adjusting the seats and steering wheel](#)" in chapter [04. ACCESS TO THE OCCUPANTS](#).

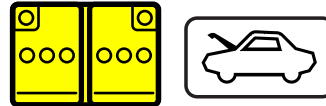

1. Open the hood.



2. Identify the 12 V battery.

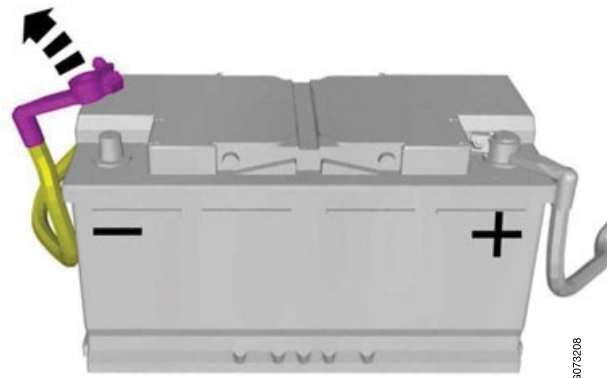

3. Locate the 12V battery's charging points and disconnect the 12V negative cable.

If the 12V battery is to be disconnected completely, the ground/minus pole must be disconnected, otherwise there is a risk of short circuits. The negative pole must be protected against renewed contact (insulation, tying away, bending away). If the battery is disconnected, it should be checked whether the vehicle is actually voltage-free. The

03. DISABLE DIRECT HAZARDS / SAFETY REGULATION

extinguishing of the hazard warning lights or the interior lighting can serve as a sign.

High voltage Manual service disconnect

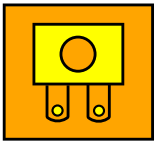

The Polestar 2 have a manual high voltage service disconnect plug. The high voltage service disconnect plug is located in front of the right rear passenger under a flap that must be opened. The orange rubber protective cap underneath the flap must be removed. Please see the location below.

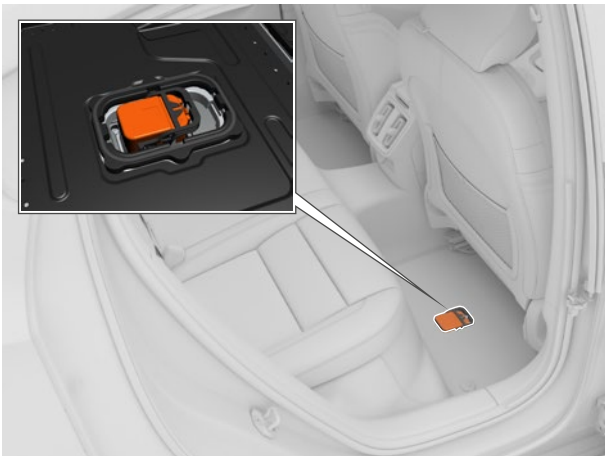

Disconnect the high voltage service plug

This operation also disconnects the traction battery from the rest of the system.

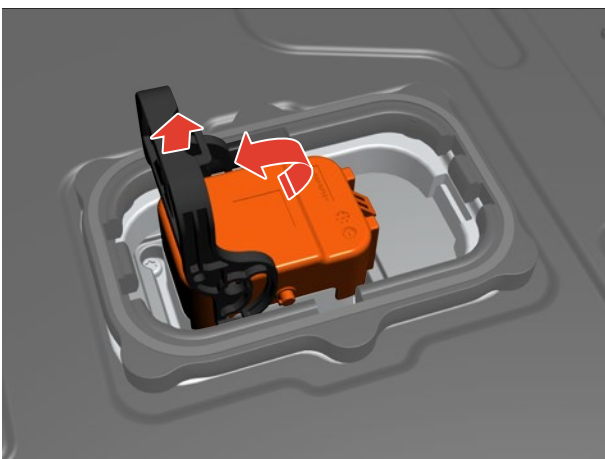

1. Pull the lever to the rear.

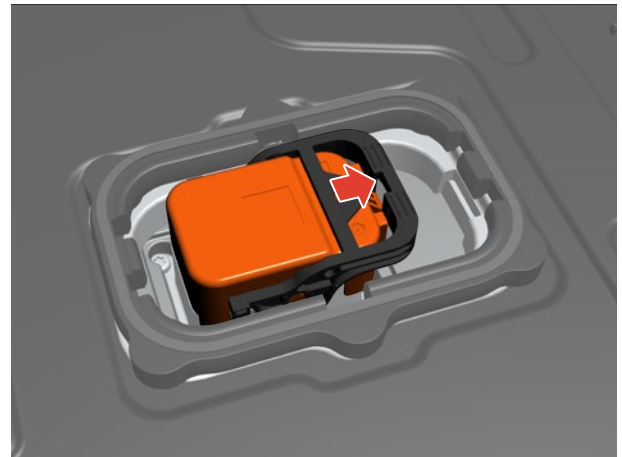

2. Turn lever upwards and pull out plug in upward direction.



WARNING

- Shutting off power to an electrical vehicle does not de-energize the battery, and a shock hazard may still be present.
- If not absolutely necessary, do not touch any of the high voltage harnesses and/or components. Touching high voltage components, wires or harnesses might result in great personal injury or death.
- If the situation requires operations on any of the high voltage components and/or harnesses, always wear the appropriate PPE to avoid electrical shock. A failure to do so can result in serious injury or death.
- NEVER assume that the electrical vehicle is turned OFF because it is silent. The electrical motor is silent and may still be running. When possible, always take appropriate actions to turn the vehicle completely off and disconnect the high voltage system before performing rescue operations.
- Regardless of which procedure is used to disable the high voltage system, always assume that high voltage components are energized. Take proper actions to avoid unnecessary risks.

Discharge of residual voltages

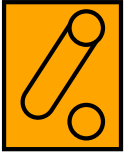

In case of an accident with airbag and/or belt pretensioner activation or after an unexpected malfunction, the discharge circuit ensures that the high voltage system is free from

voltage after approximately 10 seconds.

After switch-off/deactivation of the vehicle the high voltage system is also de-energized after approx. 10 seconds!

Personal protection clothing and emergency equipment

Use insulated clothing, such as gloves and shoes as well as a safety shield specified to be able to withstand up to 1000 V.

Use insulated tools when working on the vehicle and its components. Use solvent resistant protection gloves and shoes in the event of a traction battery electrolytic solution leakage.

Ending the charging of the traction battery

1. End charging by pressing the button next to the charging input socket or via the button in the center display.

! IMPORTANT

Before unplugging the charging cable from the vehicle's charging input socket, charging must be ended using the button located next to the charging input socket. This must be carried out even if the doors on the vehicle are already unlocked. If charging is not ended before the charging cable is disconnected, this may lead to damage to the charging cable or to the system.

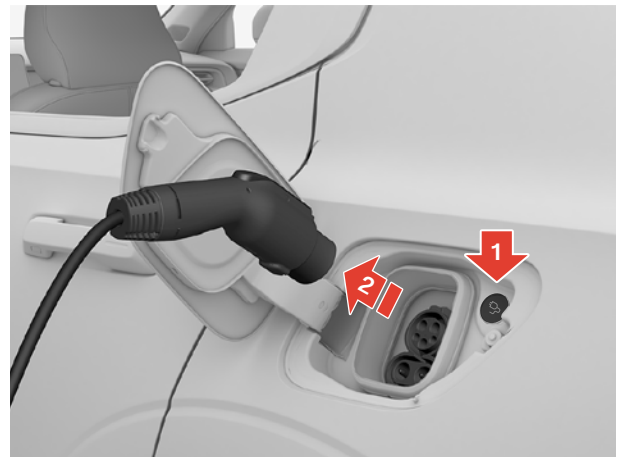

2. Depress the lock control in the charging cable handle - the charging cable's locked handle releases/is unlocked. Then unplug the cable from the vehicle's charging input socket and close the hatch.

The charging cable is locked automatically

If the charging cable is not unplugged from the charging input socket, it is locked in again automatically shortly after unlocking. The charging cable can be unplugged again using the button next to the charging input socket or via the button in the center display.

03. DISABLE DIRECT HAZARDS / SAFETY REGULATION

Unplugging the charging cable with the mechanical emergency handle

If the charging cable will not unplug from the vehicle's charging input socket when charging has been ended (via the button next to the charging input socket, in the center display, or via the charging station's user interface) and the vehicle is equipped with mechanical emergency handle, follow the instructions below.



WARNING

Before using the emergency handle, check in the driver display that charging is complete. Do not use the emergency handle while charging is in progress. If the charging cannot be ended, turn off the power to the charging socket before using the emergency handle.

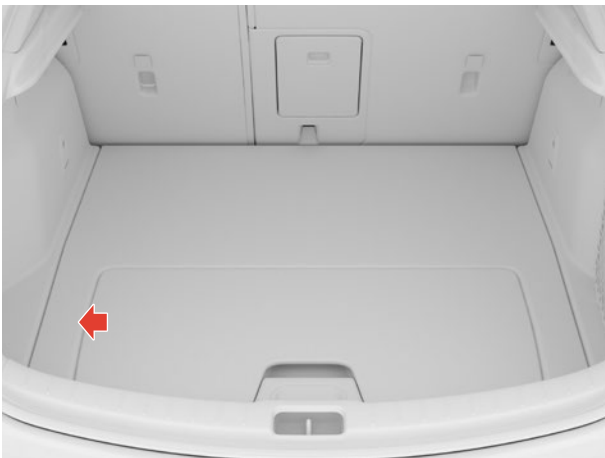

When the charging cable cannot be unplugged from the charging input socket, unplug the charging cable using the mechanical emergency handle.

1. Open the vehicle's cargo area and fold up the load floor. Lift away the recessed floor panel.
 - > The mechanical emergency handle is located under the floor panel.
2. Grasp the emergency handle and pull it until it stops.
3. Move the emergency handle back in its original location.
 - > The emergency handle travels back automati-

cally the next time charging begins.

4. Wait approximately 5 seconds before unplugging the charging cable from the vehicle's charging input socket.
5. Refit the floor panel and fold down the load floor. Close the vehicle's cargo area.

Access to the occupants

Before attempting to access to occupants, inspect the level of damage of the electrical vehicle using caution.

Look for indicators that the high voltage system has been damaged, such as:

- High voltage component casings are damaged
- There is a cut or damage of the harnesses
- Arching of sparking
- Smoke
- Offensive odor
- Etc.

Proceed according to the following scenarios:

If the high voltage system is intact and occupants CAN be accessed without using extrication tools

1. Turn off the vehicle and stabilize it. See [02.IMMOBILISATION / STABILISATION / LIFTING](#)
2. Make sure the high voltage system is disconnected. See [03.DISABLE DIRECT HAZARDS/SAFETY REGULATIONS](#)

After the high- voltage system is shut down, no wait period is needed and occupant assistance can start immediately.

If the high voltage system is intact and occupants CANNOT be accessed without using extrication tools

1. Turn off the vehicle and stabilize it. See [02.IMMOBILISATION / STABILISATION / LIFTING](#)
2. Make sure the high voltage system is disconnected. See [03.DISABLE DIRECT HAZARDS/SAFETY REGULATIONS](#)

After the high voltage system is shut down, occupant assistance operations using extrication tools can start immediately, but be very careful the next ten (10) minutes and do not cut through or damage any of the harnesses, components or battery of the high voltage system. Look at the schematics in section [COMPONENT OVERVIEW](#) of this manual to locate the high voltage components.

If the high voltage system is damaged

1. Approach the vehicle with extreme caution.
2. Use appropriate PPE
3. Shut down the high voltage system, see [03.DISABLE DIRECT HAZARDS/SAFETY REGULATIONS](#), or assist the occupants.

It takes at least ten (10) seconds for the system to be de-energized after high voltage shut down, the wait time of ten (10) seconds must be observed.



WARNING

Operating on the vehicle when the high voltage system is damaged can pose a great risk of personal injury or death. Take extreme care and use caution when performing rescue operations.

Body framework

The body consists of five different grades of steel (steel alloys). Please see the differences in below overview image.

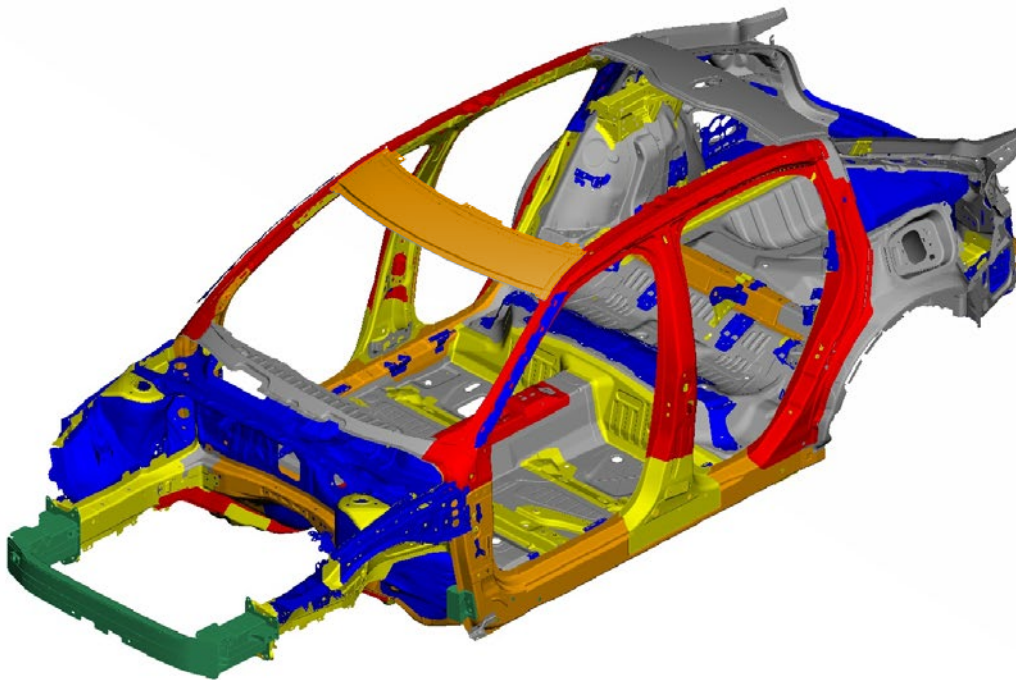

- ① Mild steel
- ② High strength steel
- ③ Very high strength steel

- ④ Extra high strength steel
- ⑤ Ultra high strength steel
- ⑥ Aluminium

04. ACCESS TO THE OCCUPANTS

Glass types

The vehicle is equipped with several different types of windows, glass and mirrors. Some of the windows in the car are laminated.

The windshield and the panoramic roof has laminated glass. Laminated glass is also available as an option for some other glass surfaces.



The symbol shows the windows containing laminated glass².

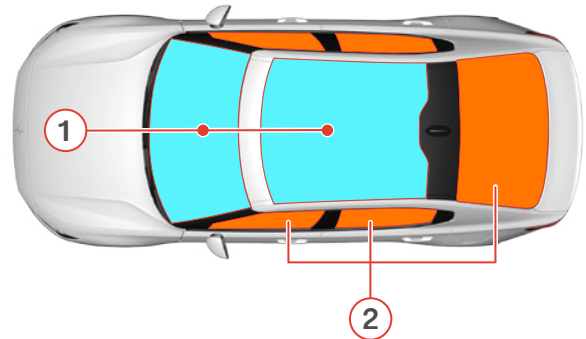

① Laminated glass

② Tempered glass

² Does not apply to windshield and panoramic roof*, which are always laminated and therefore do not have this symbol.

No-cut zones

Use appropriate tools like a hydraulic cutter. The areas which are high-lighted in the image below are not allowed for cutting.

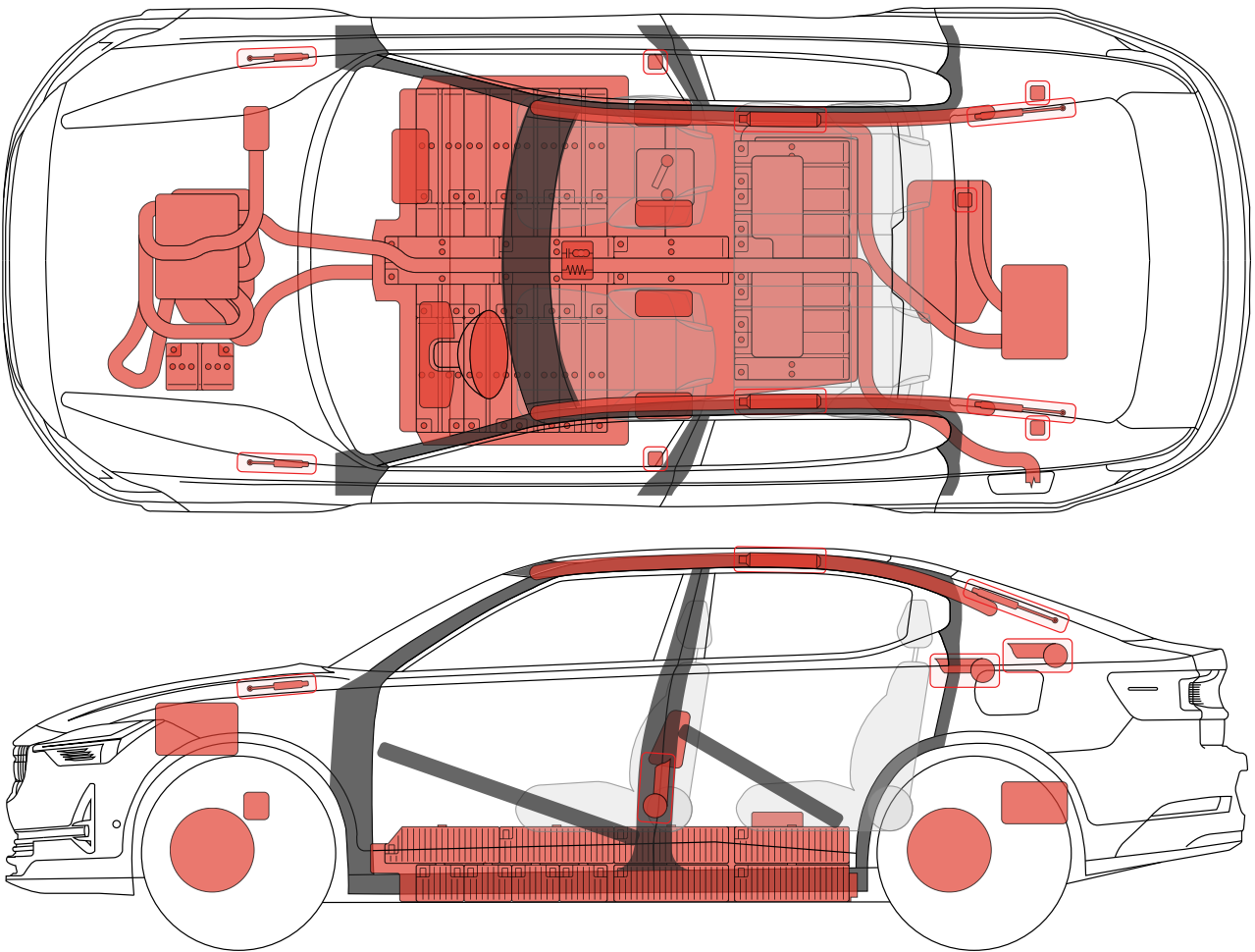

WARNING

Do not cut in any high voltage related areas, gas struts, gas generators, airbags or other hazards, it can result in serious personal injury or death from electrical shock.



WARNING

The traction battery is located below the floor pan. Never push on the floor pan inside the vehicle. Doing so can breach the traction battery or damage the high voltage cables, which can cause serious injury or death.

Adjusting the seats and steering wheel

Adjusting the power front seat

The front seats are adjusted from the control on the front seat's seating section.

! IMPORTANT

If the power front seats need to be adjusted, this must be done before the [12 V battery is disconnected](#).

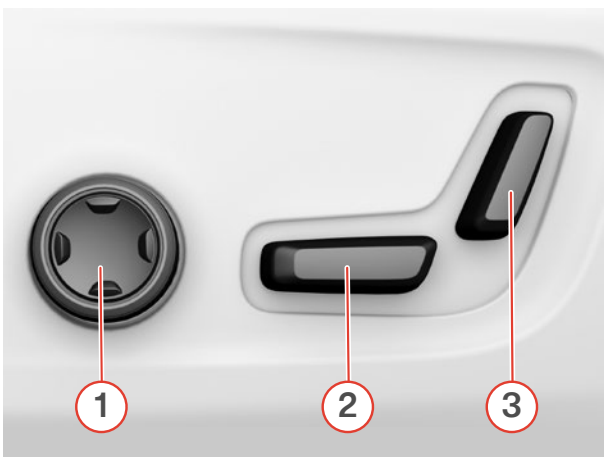

- ① Move the seat forward/backward by adjusting the control forward/backward.
- ② Raise/lower the seat by means of adjusting the control up/down.
- ③ Change the backrest inclination by adjusting the control forward/backward.

Only one movement (forward/back/up/down) can be made at a time. The backrests of the front seats cannot be lowered fully forward.

Adjusting the steering wheel



The steering wheel can be adjusted in different positions.

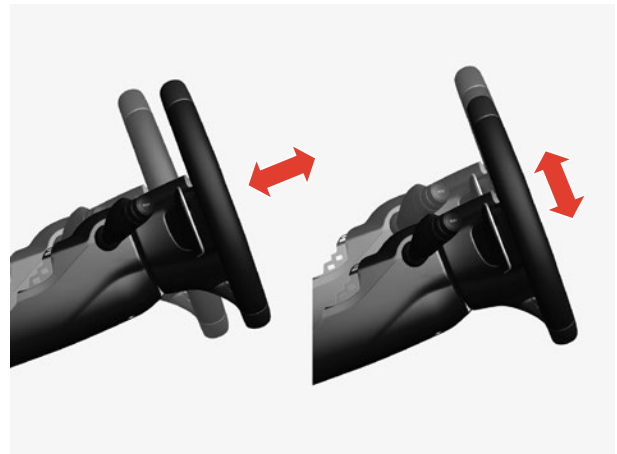

1. Push the lever forwards to release the steering wheel.
2. Adjust the steering wheel to wanted position.
3. Pull the lever back to fix the steering wheel in place. If the lever is stiff, press or raise the steering wheel slightly at the same time as you move the lever back.

Airbags and seat belt pretensioners

The vehicle is equipped with a number of different airbags in order to assist in protecting driver and passengers.

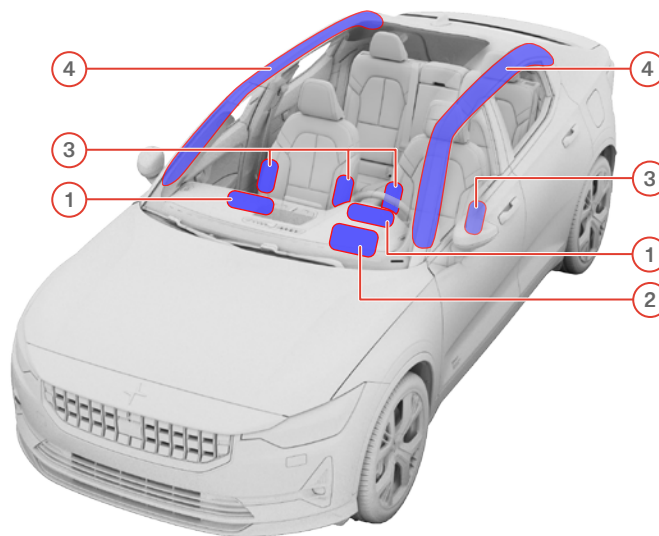

- ① Front airbags
- ② Knee airbag
- ③ Side airbags
- ④ Inflatable curtains

In addition to the airbags the seatbelts helps reducing the injuries to occupants of the vehicle. Seat belt pretensioners are placed in connection to the seatbelts. Please see the [COMPONENT OVERVIEW](#) in [Chapter 05](#) for an overview of the placement of the seat belt pretensioners.



WARNING

The airbag system's control module is located in the center console. If the center console is drenched with water or other liquid, disconnect the cables to the 12V battery. Do not attempt to turn on the ignition since the airbags may deploy. Recovering the vehicle. Polestar recommends that it is transported to an authorised workshop.

Component overview

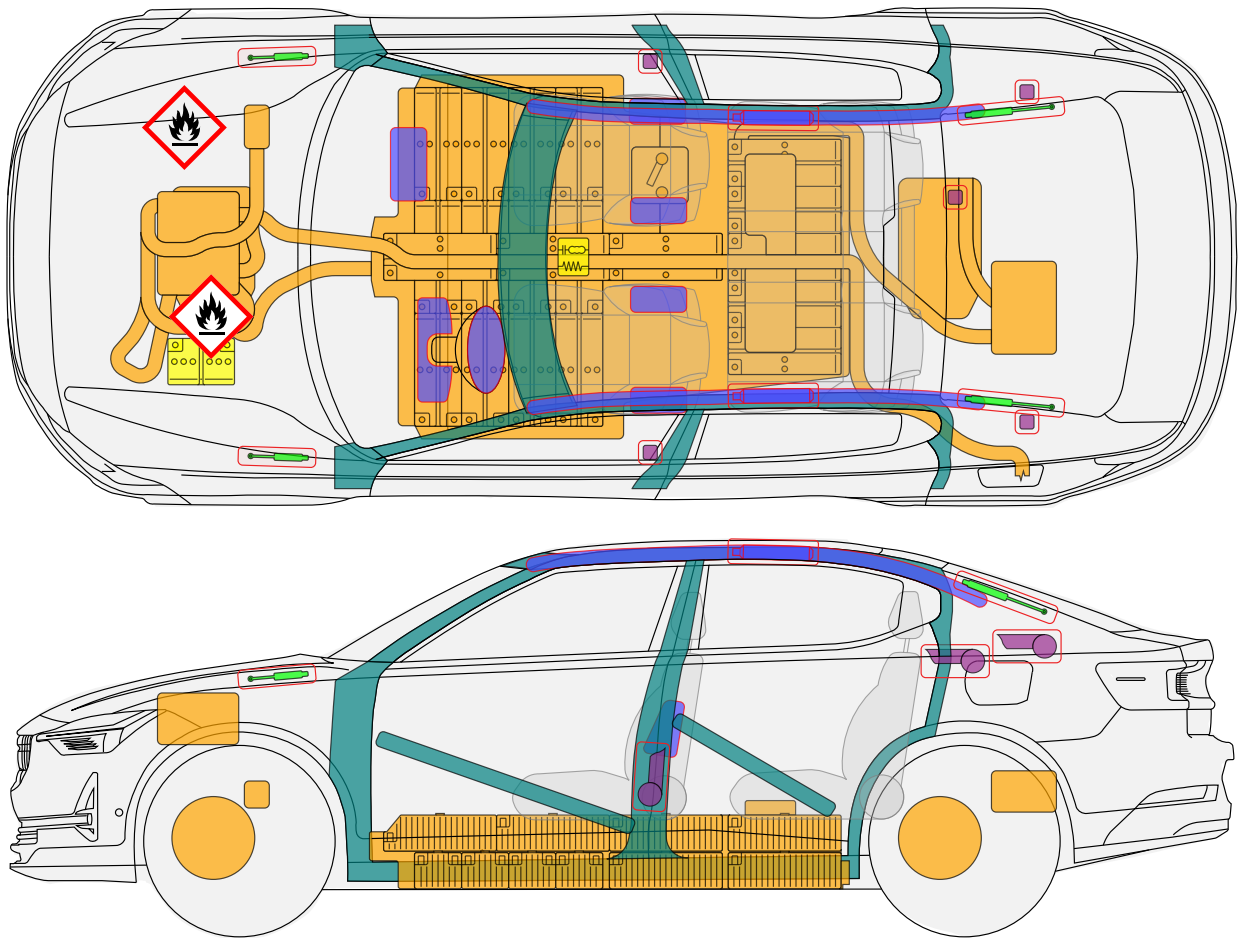

WARNING

The battery assembly cover should never be breached or removed under any circumstances, including fire. Doing so might result in severe electrical burns, shocks, or electrocution.

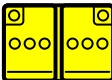
Figure	Meaning
	Airbag/side air curtain
	Battery, low voltage

05. STORED ENERGY / LIQUIDS / GASES / SOLIDS

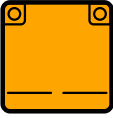









Figure	Meaning
	Battery pack, high voltage
	Stored gas inflator
	Gas strut/Preloaded spring
	High voltage power cable
	Seat belt pretensioner

Figure	Meaning
	Reinforced structure of vehicle body
	High voltage emergency disconnect
	SRS Control unit
	Brake fluid container
	Coolant system (std glycol)

First Aid Measures

Under normal conditions of use, the traction battery and the high voltage system do not present any risk of exposure to its content.

Please see the section "[High voltage Manual service disconnect](#)" in chapter [03.DISABLE DIRECT HAZARDS/SAFETY REGULATIONS](#).

Electric Shock/Electrocution



Seek immediate medical assistance if an electrical shock or electrocution has occurred (or is suspected).

Inhalation of Electrolyte Vapors



If inhalation of electrolyte vapors occurs, move person into fresh air. If not breathing give artificial respiration and seek immediate medical assistance.

Vent Gas Inhalation



The constituent battery cells are sealed and venting of cells should not occur during normal use. If inhalation of vent gases occurs, move person into fresh air. If not breathing give artificial respiration. Seek immediate medical assistance.

Treatment of waste water



According to normal procedure.

For handling in workshop, please see Vida.

Emergency rescue in case of fire

In case of fire not involving the traction battery



If there is a fire that has not spread or affects the traction battery, it can be extinguished using typical vehicle fire fighting procedures.

WARNING

Do not make contact with any high voltage components.

WARNING

While performing operations on the vehicle when a fire is involved, always consider the vehicle energized. Do not touch any part of the vehicle. Use appropriate personal protective equipment, including Self Contained Breathing Apparatus (SCBA).

In case of fire involving the traction battery

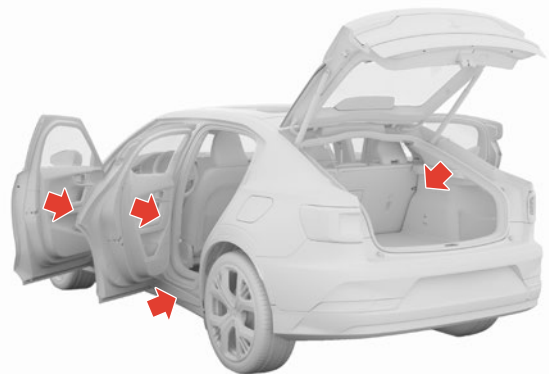

Apply water to the floor of the vehicle and underneath it to cool down the battery.



If the traction battery catches fire or is exposed to great heat or if any other incidents have occurred that might pose a risk of the battery catching fire, i.e. if the battery is bent, twisted, cracked or breached in any way, always use large amounts of water to cool the battery. Use pure water to cool down the area around the battery. It may be prudent to have a sufficiently large water supply and/or the possibility to obtain/request additional water supplies when responding to a vehicle accident that involves fire.

NOTE

The fire fighting procedure will take time and will require a lot of water.

! IMPORTANT

- Battery fires can take a long time to fully extinguish. This means that the battery might start burning again even after a fire seemingly have been extinguished.
-  Never assume that the battery has cooled down or that it no longer poses a threat of a new fire emerging. Always take proper actions to make sure that the battery is cooled down completely, i.e. by use of heat camera or some other (equivalently suitable) tool to determine the status of the battery heat level.
- Smoke and/or steam, among other irregularities, may indicate that the battery is still heating somewhere.
- Turning, tipping or lifting the vehicle can cause a re-ignition of the traction battery. Always inform the next responder of the risk of the battery re-igniting, and what to do in such event.

The traction battery needs to be monitored until it has been determined to be completely cooled, before leaving an accident and/or releasing the vehicle to second line responders, such as law enforcement and/or towing personnel.



WARNING

When the vehicle has been subject of a fire, submersion or collision that in any way have compromised the integrity of the traction battery, the vehicle should be stored in an area secured from any exposure.

Emergency rescue in the case of submersion

Treat a submerged vehicle wearing appropriate PPE. Remove the vehicle from the water and continue with normal high voltage disabling.

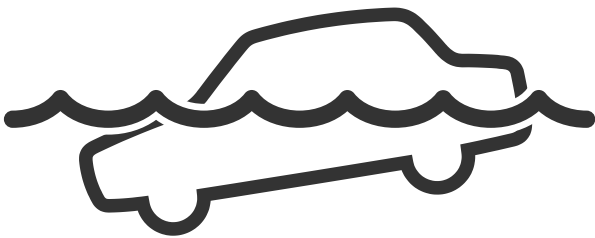

WARNING

Always wear Personal Protective Equipment (PPE) while handling a submerged vehicle, otherwise it can result in serious injury or death from electrical shock.



WARNING

Do not touch the high voltage components, or harnesses when the vehicle is in the water.

Hauling of the vehicle from the scene after an accident

If the vehicle cannot start after an accident it needs to be hauled from the scene of the accident.

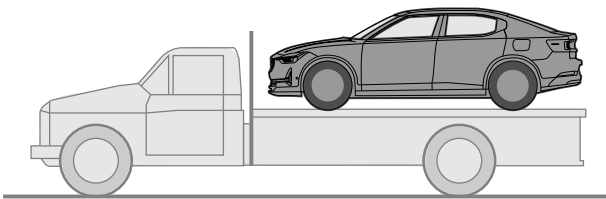

When hauling an electrical vehicle, it shall either be lifted off from the ground or towed up onto a recovery vehicle's platform.

When lifted, all four wheels must be lifted off from the ground.

When towed, the Towing mode must be activated (please see the section "Activating the towing mode"). If the circumstances make it impossible to activate the Towing mode, trolleys can be put under the wheels, making sure the wheels don't rotate.

It is only permitted to tow the vehicle up onto a recovery vehicle's platform. It is not permitted to haul the vehicle with any of its wheels rolling on the ground.

While hauling, no person is allowed to be inside the vehicle being hauled.



WARNING



After a reaction from a damaged traction battery, it must be secured until it has reached approximately ambient temperature. The use of a thermal imaging camera or an IR thermometer is recommended. Before transporting the vehicle (e.g. by a towing company), the condition of the lithium-ion battery must be re-checked.

Prerequisites for hauling

1. Activate emergency warning lamps
2. Make sure all doors are closed and that the mechanical locks are latched up. If possible activate Towing mode (see below).
3. Make sure the vehicle is shifted to OFF. See the section "[Vehicle stopping operations](#)" in chapter [02. IMMOBILISATION / STABILISATION / LIFTING](#).

Activating Tow mode

Towing mode is used when the vehicle has to roll freely in order to pull it up onto a recovery vehicle's platform, for example.

1. Tap  in the center display.
2. Tap **More**.
3. Tap **Car status**.
4. Select **Tow Mode**.
5. Follow the instructions on the screen.
 - > The vehicle is now in tow mode and can roll freely.

Deactivating Tow mode

1. Make sure that the vehicle is stationary.
2. Activate the parking brake.
 - > Tow mode is now deactivated.

! IMPORTANT

- If it is impossible to utilize platform-type goods vehicle to perform vehicle hauling, rigid attachment means may be used to remove the vehicle to a temporary safe zone awaiting rescue.
- For the method of rigid hauling, long distance hauling shall be avoided and the hauling vehicle shall not exceed a speed of 5 km/h.
- The vehicle may not be hauled away from the scene if the vehicle in any way causes a security risk.

! WARNING

A damaged traction battery can react either immediately or with a delay due to severe damage (e.g. crushed, broken or cracked housing) or exposure to water or fire. Therefore, watch out for any signs (e.g. smoke, heating, noise, sparks, etc.) while working on a vehicle with a lithium-ion battery which has been damaged in a very severe accident. If the lithium-ion battery reacts, protective measures must be taken.

! WARNING

The vehicle may only be loaded and transported if the reaction has ended to such an extent that it can be assumed that no further reaction is to be expected on the transport route. The shortest and safest route must be chosen. Passages through tunnels should be avoided. In some cases it may be appropriate for the towing vehicle to be accompanied by a fire-fighting vehicle.

! WARNING

The responsible persons of the towing company, the workshops and, if applicable, the disposal companies must be informed of the special features and risks of the vehicle!

Storage recommendations

A damaged traction battery can react either immediately or with a delay due to severe damage (e.g. crushed, broken or cracked housing) or exposure to water or fire. Therefore the vehicle involved in the accident must be parked in a suitable place outside unless it is analyzed and safe, because the traction battery still has the theoretical potential to react until the system is secured, please see chapter [03. DISABLE DIRECT HAZARDS / SAFETY REGULATION](#).

The parking space must be marked accordingly (signage/delimitation). A distance of at least 5 meters (15 feet) from other vehicles, buildings or combustible objects must be maintained.



WARNING

If a vehicle has been damaged (battery enclosure has been dented or compromised), it is possible that heating is occurring that may eventually lead to a fire.

Damaged or opened cells/batteries can result in rapid heating (due to exothermic reaction of constituent materials), the release of flammable vapours, and propagation of self-heating and thermal runaway reactions to neighbouring cells.

Smoke may be an indication that a thermal reaction is in progress. If no smoke, flame, sign of coolant leakage, or signs of heat has been observed the vehicle may be disconnected and moved to a safe location. To obtain specific instructions for evaluating, disconnecting, and preparing a damaged vehicle for transport, please contact the Polestar team. A damaged vehicle should be monitored during storage for evidence of smoke, flame, sign of coolant leakage, or signs of heat.

If full-time monitoring of the vehicle is not possible (for example during extended storage), the vehicle should be moved to a safe storage location. A safe storage location for a damaged battery will be free of flammable materials, accessible only by trained professionals, and 15 meters (50 feet) away from occupied structures. For example, a fenced, open yard may be an appropriate safe location. It is possible that a damaged battery may sustain further damage during transportation and may lead to a fire. To further reduce this risk, handle the damaged battery with extreme caution until analyzed.

09. IMPORTANT ADDITIONAL INFORMATION

10. EXPLANATION OF PICTOGRAMS USED















Figure	Meaning
	Electric vehicle
	Warning/Caution
	High voltage component
	SRS Control unit
	Power shut down
	Smart key distance
	Lifting point
	Disconnection of high voltage
	Fuse box disabling high voltage
	Opening hood
	Seat adjustment, longitudinal
	Seat height adjustment
	Steering wheel tilt
	Airbag
	Battery, low voltage

Figure	Meaning
	Traction battery pack, high voltage
	Airbag inflator
	Gas strut/Preloaded spring
	Ultra capacitor, low voltage
	High voltage power cable
	Seat belt pretensioner
	High strength zone
	Dangerous voltage
	Flammable
	Hazardous to human health
	Environmental hazard
	Use water to extinguish
	Use wet foam to extinguish
	Use dry foam to extinguish
	Use IR Camera

